

Handcrafted tables
for this generation.
And the next.

we
are
arco

we
make
tables

After 118 years,
we're sure of one
thing: there's no
shortcut to great
craftsmanship.

we
are
arco

we
make
tables

Table of contents

Introduction	We are Arco	6	Seating & Low seating	Arc	170
	Why we do what we do	10		Bock	172
	Our promise	14		Close	176
Sustainability	For the love of wood	20	Ease	182	
	Arco on sustainability	30	Flux	186	
	Product Eco Passport	32	Frame	188	
	Refurbish	36	Laze	192	
	Care & Maintenance	40	Re-volve	196	
			Side by side	200	
Projects	Reference projects	44	Sketch Office	204	
			Sketch Regular	208	
Tailoring	We tailor furniture	58	Low tables & Flexible objects	Bow	216
				Pivot	220
				Tablet	224
				Tre	226
				Utensil	228
Sales information	Get in touch	60	Materials	Material & Color inspiration	234
	Visit us	61		Material overview	252
Tables	Balance	72			
	Base (Local Wood)	76			
	Cast (Local Wood)	80			
	Dew	84			
	Essential	90			
	Essenza	94			
	Grid	98			
	HAT	106			
	Joist	110			
	Kami	114			
	Move	118			
	Shift	124			
	Slim	128			
	Slim+	134			
	Spazio	140			
	Trestle	142			
		Cable management	147		Colophon



Arco is located in Winterswijk, an area in the east of the Netherlands, also known as 'De Achterhoek'. In this brochure we give you an impression of the neighborhood where we come from.

we are arco

Kuipersweg, Winterswijk
N 51.54.688, E 6.44.653

we are arco



Jorre van Ast and Floor van Ast,
fourth generation owners.

We've been making tables and the objects that complement them since 1904. That's four generations as an independent, family-owned concern – a lot of sweat, skill and splinters.

Our factory is located in de Achterhoek, a region in the east of Holland renowned for its natural beauty. This proximity to nature has inspired the craftspeople of Arco to make products with the finest wood, often locally sourced, and as sustainably as possible.

Thanks to our roots and experience, we've learned a thing or two. About beauty, craft, human nature... and nature in general.

For instance: "Beauty" is another word for quality. Craft requires humility.

It's better to design for timelessness, not trends.

And also: keep one eye on what people want, and the other on what the planet needs.

Act with respect. Whether you're dealing with a colleague, a customer, or a forest.

Invest in new technologies, new skills, new materials and new talent (we're pretty open-minded for a 118-year-old).

We call all this "the New Craftsmanship."

And it's why we make handcrafted tables, for this generation and the next.

And the next.

we make tables

Bij Arco maken we sinds 1904 tafels en objecten die onze tafels complementeren. Al vier generaties zijn we een onafhankelijk familiebedrijf - het resultaat van hoop zweet en tranen... en splinters in onze vingers.

Onze fabriek staat in de Achterhoek, een streek bekend om zijn natuurlijke schoonheid. Een omgeving die de vakmensen van Arco inspireert te werken met het beste hout, waar mogelijk lokaal hout, en op een zo duurzaam mogelijke manier.

Onze geschiedenis en onze ervaring heeft ons veel geleerd. Over schoonheid, vakwerk en over mensen en natuur.

Zo is 'schoonheid' bij ons synoniem voor kwaliteit. En heeft vakwerk hier alles met respect te maken

We geloven dat tijdloos ontwerp beter is dan trendy design.

Terwijl we oog houden voor wat mensen vragen, zijn we met ons hart altijd bij de planeet.

We staan voor respect: voor elkaar, voor onze klanten en voor onze wereld.

En we blijven investeren in nieuwe technieken, nieuwe vaardigheden, nieuwe kennis, nieuw materiaal en nieuw talent. (Ja, we zijn best ruimdenkend voor een 118-jarige.)

Wij noemen dit 'Het Nieuwe Vakmanschap'.

En dit motiveert en inspireert ons om handgemaakte tafels te produceren, voor de huidige én komende generatie. En voor alle generaties daarna.

& the objects to compliment them.

Wir stellen schon seit 1904 Tische und dazugehörige Objekte her. Das sind vier Generationen als unabhängiges Familienunternehmen – und eine Menge Arbeit, Schweiß und Späne.

Unser Werk befindet sich im Achterhoek der Niederlande, einer Gegend, die für die Schönheit ihrer Natur bekannt ist. Diese Nähe zur Natur hat die Handwerker von Arco dazu inspiriert, Produkte aus dem besten Holz herzustellen, das, wo immer möglich, aus der Region und nachhaltig bewirtschafteten Wäldern stammt.

Unsere Geschichte und unsere Erfahrung haben uns vieles gelehrt ... über Schönheit, Handwerk und über Mensch und Natur.

Dazu gehört auch, dass „Schönheit“ für uns ein Synonym ist für Qualität. Gutes Handwerk erfordert Demut.

Ein gutes Design sollte zeitlos sein und nicht von Trends bestimmt werden.

Für uns ist wichtig, beides im Blick zu haben: die Wünsche der Menschen und unseren Planeten.

Respekt zu zeigen – füreinander, für unsere Kunden und für unsere Umwelt.

In neue Technologien, Fähigkeiten, Materialien und Talente zu investieren (für einen 118-Jährigen sind wir ganz schön aufgeschlossen).

Wir nennen all das „das neue Handwerk“.

Und genau deshalb stellen wir handgefertigte Tische her, für diese und die nächste Generation. Und die nächste.

TABLES FOR



AND
EVERYTHING
IN BETWEEN.



HOMES,
OFFICES,
HOME OFFICES,
OFFICE HOMES



Why we do what we do

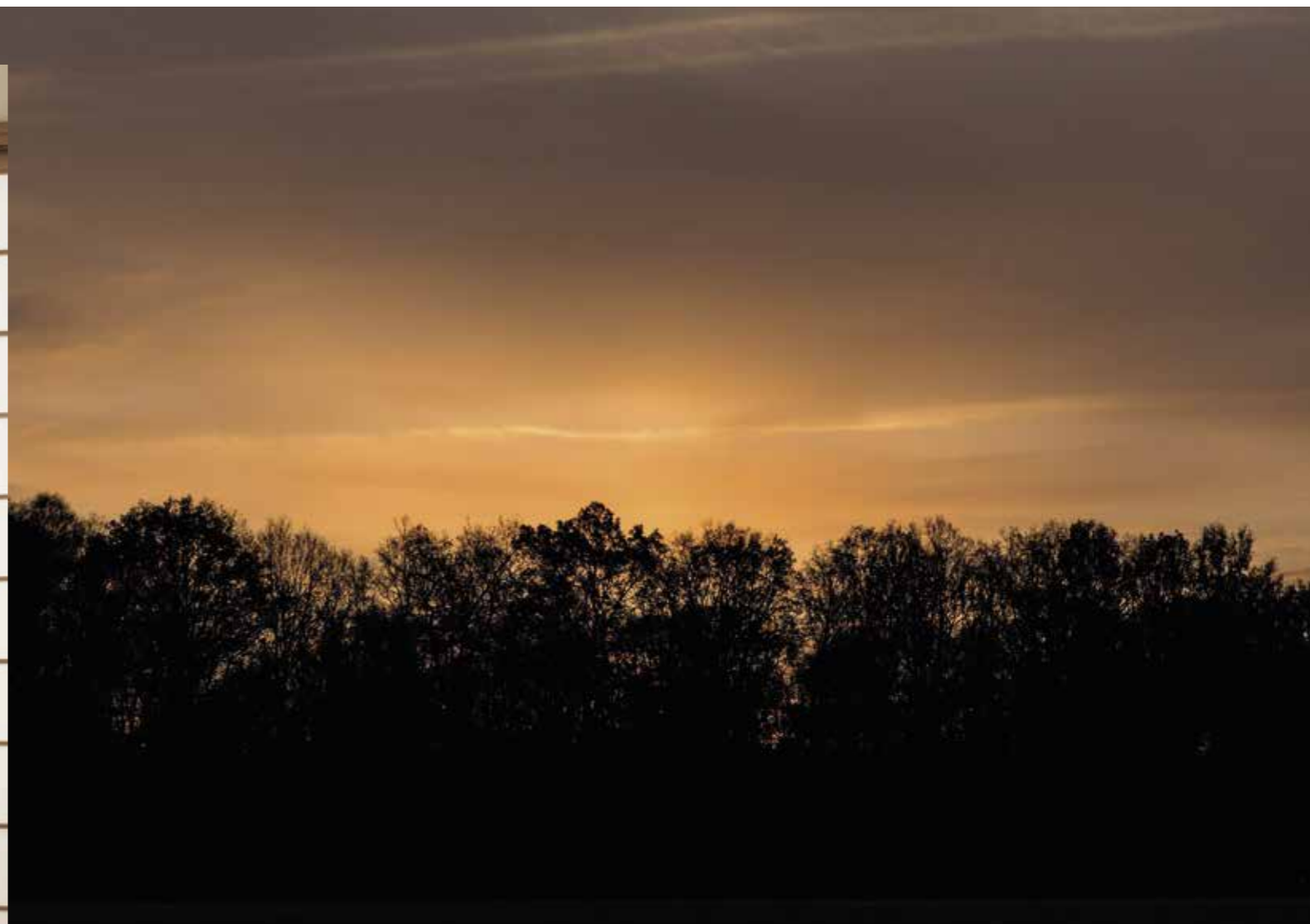

What's a table?
Four legs and a plank, right?
Right.

But it's also how we frame the day.

In the morning, it's where we greet the morning with coffee and news.

At work, a table is where deals are done and master plans made.

It's where we meet, negotiate, think big thoughts, drill down on the numbers... or soar high on the science.

A table is a stage: it's where we innovate, make careers and build companies.

It's where we assemble the jigsaw of the future, dissecting designs and debating policies. A table is a canvas: where we draw, write, code, make magic.

In the evening, a table is where we fight and make-up, get dramatic or romantic.

Or a sanctuary: where we gather the tribe and talk it out.

It's where we grab a glass a wine with our favourite person... and plan to do it all again tomorrow.

We are Arco.
We make tables.
Pull up a chair.



Why we do what we do

Wat is een tafel eigenlijk?
Een blad en vier poten, toch?
Klopt.

Een tafel bepaalt ook je dag.

Het is je welkom in de ochtend met koffie en nieuws.

Je werkt er aan prachtige plannen en de beste deals.

We ontmoeten elkaar aan tafel, overleggen, dromen groot en denken verder. Over de kleinste details en de nieuwste ontdekkingen.

Een tafel is je podium voor innovatie, waar carrières ontstaan en bedrijven opbloeien. Hier worden de puzzelstukken van je

toekomst gelegd, ontwerpen aangescherpt en politiek gefileerd.

Een tafel is je canvas: waar je schetst, schrijft, codeert, creëert.

's Avonds maken we het goed aan tafel, of we discussieren er nog even door. Het is je plek voor drama én voor romantiek.

En je thuishaven, waar je samenkomt en problemen bespreekt.

We schenken er een goed glas wijn, voor onszelf en voor de mensen die ons lief zijn.

Wij zijn Arco.
Makers van tafels.
Schuif gerust aan.

Was genau ist ein Tisch?
Ein Brett mit vier Beinen?
Richtig.

Aber er begleitet uns auch durch den Tag.

Hier starten wir morgens mit Kaffee und Nachrichten in den Tag.

Hier werden bei der Arbeit Geschäfte gemacht und Projekte geplant.

Hier treffen wir uns, diskutieren, haben große Ideen und denken nach ... über kleinste Details und die neuesten Entdeckungen.

Ein Tisch ist eine Bühne: Hier entstehen Innovationen, entwickeln sich Karrieren und Unternehmen. Hier werden die Weichen für die Zukunft gelegt, Entwürfe ausgefeilt und politische Diskussionen geführt.

Ein Tisch ist eine Leinwand: Hier zeichnen, schreiben oder programmieren wir und bringen unsere Kreativität zum Ausdruck.

Hier streiten wir uns abends und versöhnen uns wieder; hier wird es mal dramatisch und mal romantisch.

Ein Tisch ist auch Rückzugsort und Zuhause: Hier kommen wir zusammen und sprechen über das, was uns bewegt.

Hier trinken wir ein Glas Wein mit unserem Lieblingsmenschen ... und wollen all das auch morgen wieder tun.

Wir sind Arco.
Wir machen Tische.
Setzen Sie sich.



Handcrafted tables for this generation. And the next.

That headline motivates everything we do, and every piece we make. But how? And why does it benefit you?

Family & Craft

Our experts have the skilful hands and patient minds needed to realize Arco's timeless designs. Of course, we're open to the latest technology, but mostly we fashion each piece using traditional methods.

Longevity & Sustainability

An Arco table lasts... and lasts. So you can keep it forever, give it to a new family, or gift it to your children. Or grandchildren.

And on the subject of grandchildren, we're conscious of our responsibility to the environment.

While we can't claim to be fully sustainable yet, we're certainly on our way. For example, 100% of our wood is certified to the most exacting standards; just one of the ways we support the circular economy.

Product quality

We take timber very, very seriously: we use locally sourced wood and other exceptional materials, and treat our grain to the finest of finishes. And from foresters to veneer specialists, Arco's people put a lifetime of artistry into our tables, so you get a table for life.

Design quality

We collaborate with designers both local and international. While all our designers have a distinctive style, they share a common philosophy: the importance of detail, love of an ageless aesthetic, and the desire for function over fluff.

Range

Arco is a table specialist, servicing a wide variety of purposes: home, work, work-home, and all variations thereof. But our range doesn't stop at tables. We also provide objects that complement them. Consider our chairs, stools, benches, and supplementary furniture like the Pivot — a unique set of hinging drawers.

Tailoring

We prize flexibility, which is why almost all our tables can be altered to fit your needs. Choose from many options including height, color, and size. Please note: it takes at least eight weeks to handcraft each table. Why? Well, beautiful design takes time... and that goes double for beautiful, bespoke design.

So whether you're investing in an Arco table or a related item, we refute the easy choices and embrace what feels right for our craft, design, today's world, and tomorrow's challenges.

Handcrafted tables for this generation. And the next.

Dit is wat ons motiveert: in alles dat we doen en in alles dat we maken. Wat dat voor jou betekent, leggen we je graag even uit.

Familie & ambacht

Onze vakmensen hebben vaardige handen en geduldige geesten om tot onze tijdloze ontwerpen te komen. We staan altijd open voor nieuwe technologieën, maar zweren ook bij onze ervaring en ons ambacht bij de productie van onze meubels.

Levensduur & Duurzaamheid

Arco is al vier generaties lang een familiebedrijf. Onze tafels zijn al even duurzaam: ze zijn er altijd voor je. En na jou zijn ze er voor je kinderen. En je kleinkinderen.

We ontwerpen voor huidige en komende generaties: met respect voor onze wereld. We zijn op weg naar 100% duurzaamheid: met 100% gecertificeerd hout en de strengste normen tijdens onze productie. We steunen de circulaire economie.

Productkwaliteit

Wij nemen hout serieus. Heel serieus. We verwerken alleen lokaal hout en voorzien ze van de mooiste afwerkingen. Al onze Arco-collega's, van boswachters tot fineerders, voegen hun levenslange vaardigheden aan onze tafels toe. Zo krijg jij gegarandeerd een tafel voor het leven.

Ontwerpkwaliteit

Wij werken samen met ontwerpers, lokaal en internationaal. Al onze ontwerpers hebben een eigen, unieke stijl en één gemeenschappelijke filosofie: alles draait om het detail, om de liefde voor tijdloze esthetiek en om ons geloof in functionaliteit zonder frutsels.

Assortiment

Als tafelspecialist maken wij tafels voor de meest uiteenlopende doeleinden: voor thuis, op het werk en alles er tussenin. We maken tafels én de objecten die tafels compleet maken. Zoals stoelen, krukken, banken en kleinmeubelen zoals de Pivot: een uniek object met scharnierende laden.

Op maat

Wij zijn ons bewust van het belang van flexibiliteit en daarom kan bijna elke tafel aangepast worden aan je specifieke wensen. Jij bepaalt de hoogte, kleur en de grootte. In tenminste acht weken maken we je tafel met de hand. Waarom zo lang? Mooi design kost tijd. Zeker als het op maat gemaakt wordt.

Onze producten zijn het resultaat van decennialang gemakkelijke keuzes uit de weg gaan. We gaan alleen voor wat goed voelt voor ons vak, onze kijk op ontwerpen, de wereld van vandaag en de uitdagingen van morgen. En dat zie je terug in elke tafel en elk meubelstuk.

Dieser Leitsatz motiviert alles, was wir tun, und jedes Stück, das wir herstellen. Aber was das für Sie bedeutet, erklären wir gerne.

Familie und Handwerk

Unsere Fachleute besitzen die geschickten Hände und den geduldigen Verstand, die man braucht, um die zeitlosen Designs von Arco zu realisieren. Selbstverständlich sind wir offen für die neueste Technologie, wir fertigen jedoch meistens jedes Stück mit traditionellen Methoden.

Langlebigkeit und Nachhaltigkeit

Apropos Generationen: ein Arco-Tisch hält so lange, wie Sie ihn brauchen. Das bedeutet, dass Sie ihn für immer behalten, an eine neue Familie weitergeben oder an Ihre Kinder verschenken können. Oder Ihre Enkel.

Und zum Thema Enkelkinder: Wir sind uns unserer Verantwortung für die Umwelt bewusst. Wir können zwar noch nicht behaupten, dass wir komplett nachhaltig sind, aber wir sind ganz sicher auf dem Weg dorthin. So sind zum Beispiel 100 % unseres Holzes nach den anspruchsvollsten Standards zertifiziert. Dies ist nur eine Art und Weise, auf welche wir die Kreislaufwirtschaft unterstützen.

Produktqualität

Wir nehmen den Rohstoff Holz sehr ernst: Wir verwenden vorwiegend einheimisches Holz und veredeln dessen Maserung durch feinste Oberflächenbehandlungen. Vom Förster bis zum Furnierspezialisten bringen die Mitarbeiter von Arco ihre Erfahrung und ihr handwerkliches Können in die Verarbeitung unserer Tische ein, damit Sie einen Tisch fürs Leben erhalten.

Designqualität

Wir arbeiten sowohl mit lokalen als auch mit internationalen Designern zusammen. Obwohl unsere Designer allesamt über einen unverwechselbaren Stil verfügen, haben sie eine gemeinsame Philosophie: die Liebe zum Detail und zu einer zeitlosen Ästhetik sowie den Wunsch nach Funktionalität statt Firlefanz.

Sortiment

Arco ist ein Tischspezialist, der viele Einsatzbereiche bedient: zu Hause, am Arbeitsplatz, im Büro und in all deren Variationen. Aber unser Sortiment beschränkt sich nicht nur auf Tische. Wir bieten ebenso Produkte, die sie komplett machen. Dazu gehören auch unsere Stühle, Hocker, Bänke und Ergänzungsmöbel wie der Pivot – ein einzigartiges Möbel mit Schubladen zum Herausklappen.

Verarbeitung

Wir legen Wert auf Flexibilität, deshalb lassen sich fast alle unsere Tische nach Ihren Wünschen verändern. Sie können bei Höhe, Farbe und Größe aus vielen Optionen wählen. Es dauert mindestens acht Wochen, einen Tisch in Handarbeit herzustellen. Warum? Nun ja, wunderschöne Designs brauchen nun einmal Zeit ... und das gilt umso mehr für ein wunderschönes, maßgeschneidertes Design.

Unsere Produkte sind das Ergebnis jahrzehntelanger Bemühungen, einfache Entscheidungen zu vermeiden. Wir tun nur das, was sich für unser Handwerk, unsere Auffassung von Design, die Welt von heute und die Herausforderungen von morgen richtig anfühlt. Und das spiegelt sich in jedem Tisch und jedem Möbelstück wider.







FOR THE LOVE OF WOOD

At Arco, we strive to become more sustainable every day. We're not saying that because it's trendy. Sustainability is in our DNA. It has been for years. We work with a long-term perspective, making furniture for you, your children, and grandchildren. And we like to build life-long relationships with our customers and suppliers.

We put our all into making sure we continue to manufacture at our own factory in Winterswijk. And we're well on the way to 100% circularity: for every new design we focus our attention on closing the material cycle loop. We adhere strictly to EU ECO label norms. We only use water-based lacquers and stains. And we're always on the lookout for more sustainable alternatives.

Wood is our favourite material. We love its character and figure. And the feeling you get when you run your hand over it. Nearly all our tables are made from wood. Not only because it's beautiful, but above all because wood is sustainable. Wood is reusable

and stores huge amounts of CO₂. For example, a 280 cm Base table contains 149 kilos CO₂. As a comparison, that's enough to compensate for the emissions of a middle-range car driving 1,252 km.

As a business with the STIP quality mark, we get our wood – American walnut included – from sustainably managed, FSC® and PEFC certified, European forests. In these sustainably managed forests, logging is carried out responsibly. As a result, the trees have more space to flourish, get more light, and grow faster. And growing trees absorb more CO₂. Read more about our working practices on the following pages.



UIT LIEFDE VOOR HOUT

Bij Arco worden we elke dag duurzamer. Dat klinkt modieus. Maar duurzaamheid zit in ons DNA. Al jaren. We werken voor de lange termijn. Maken meubels voor jou, je kinderen én kleinkinderen. En gaan met klanten en leveranciers het liefst relaties aan voor het leven.

We doen er alles aan om in Nederland in onze eigen fabriek in Winterswijk te blijven produceren. En we zijn inmiddels hard op weg naar 100% circulariteit: in elk nieuw ontwerp gaat onze aandacht naar het sluiten van de materialenkringloop. We werken strikt volgens de normen van het EU ECO label. We gebruiken alleen watergedragen lakken en beitsen. En we blijven kijken naar duurzamere alternatieven.

Hout is ons lievelingsmateriaal. We houden van het karakter en de tekening. En van het gevoel als je er met je hand overheen gaat. We maken bijna al onze tafels van hout. Want hout is mooi, maar voor alles duurzaam. Hout is herbruikbaar en houdt enorm veel CO2 vast. In een Base tafel van 280 cm bijvoorbeeld zit 149 kilo CO2. Ter vergelijking, dat compenseert de uitstoot van een middenklasse auto die 1.252 km rijdt.

Als bedrijf met het STIP-keurmerk halen we ons hout, ook ons Amerikaans notenhout, alleen uit duurzaam beheerde bossen in Europa: FSC®- en PEFC- gecertificeerd. In duurzaam beheerde bossen wordt verantwoord gekapt. Waardoor bomen er vrijer staan, meer licht vangen en harder groeien. En groeiende bomen houden CO2 vast. Op de volgende pagina's lees je precies waar we mee werken.



AUS LIEBE ZUM **HOLZ**

Wir bei Arco werden jeden Tag nachhaltiger. Nachhaltigkeit ist für uns kein Trend, sondern hat bei uns Tradition. Und das seit vielen Jahren. Wir arbeiten zukunftsorientiert. Wir machen Möbel für Sie, Ihre Kinder und Kindeskindern. Und wir ziehen es vor, mit Kunden und Lieferanten Beziehungen auf Lebenszeit einzugehen. Wir legen sehr viel Wert darauf, auch in der Zukunft in den Niederlanden in unserer eigenen Fabrik in Winterswijk zu produzieren. Und wir sind auf dem besten Weg zur perfekten Kreislaufwirtschaft: Bei jedem neuen Design bemühen wir uns um einen geschlossenen Materialkreislauf. Wir arbeiten streng nach den Standards des EU-ECO-Labels und verwenden ausschließlich Lacke und Beizen auf Wasserbasis. Und wir sind stets auf der Suche nach nachhaltigeren Alternativen.

Holz ist unser Lieblingsmaterial. Wir lieben seinen Charakter und seine Maserung. Und das Gefühl, wenn man mit der Hand darüber streicht. Fast alle unsere Tische sind aus Holz. Denn Holz ist nicht nur schön, sondern vor allem nachhaltig. Holz ist wiederverwendbar und speichert eine enorme Menge an CO2. In einem 280 Zentimeter langen Base Tisch stecken beispielsweise 149 Kilo CO2. Zum Vergleich: Das gleicht die Emissionen eines Mittelklassewagens über eine Strecke von 1.252 Kilometern aus.

Als Unternehmen mit STIP-Gütesiegel beziehen wir unser Holz, auch unseren amerikanischen Nussbaum, ausschließlich aus nachhaltig bewirtschafteten, FSC®- und PEFC-zertifizierten Wäldern in Europa. In nachhaltig bewirtschafteten Wäldern findet ein verantwortungsvoller Holzeinschlag statt. So stehen die Bäume freier, erhalten mehr Sonnenlicht und wachsen schneller. Und beim Wachsen speichern Bäume CO2. Im Folgenden können Sie genau nachlesen, womit wir arbeiten.



SOLID WOOD: LOCAL WOOD



Local Wood is wood from the region around our factory in Winterswijk (the Netherlands). We only work with local partners, including for drying and sawing. Nature stays visible in Local Wood because knots and colourings give furniture its individuality.

Local Wood is hout uit de regio rond onze fabriek in Winterswijk. We werken alleen met lokale partijen: ook als het om drogen en zagen gaat. In Local Wood blijf je de natuur zien. Want noesten en verkleuringen geven meubels een heel eigen gezicht.

Local Wood ist einheimisches Holz aus der Gegend um das Werk von Arco in Winterswijk. Wir arbeiten bei allen Prozessen ausschließlich mit lokalen Anbietern zusammen, auch beim Trocknen und Sägen. Bei Local Wood ist die Natur noch zu sehen, denn Astlöcher und Farbunregelmäßigkeiten verleihen den Möbeln einen ganz eigenen Charakter.

SOLID WOOD: ARCO PREMIUM QUALITY



Arco premium quality wood is made from bonded layers of solid wood of varying widths. It's finished with mat-natural finish (hereafter N-finish), project finish (hereafter P-finish) or with oil. Arco premium quality solid wood inevitably contains knots, deformations and black spots, but none of this is visible. But it may occur on the underside of a tabletop, for example.

Arco premium quality hout bestaat uit verlijmd massieve houtstroken van verschillende breedtes. Die werken we af met olie, N-lak (mat-naturel) of P-lak (projectlak). Noesten, vergroeiingen en zwarte pitjes zijn er bij Arco premium quality wel, maar je ziet ze niet. Ze kunnen wel voorkomen aan bijvoorbeeld de onderkant van een tafelblad.

Holz in Arco-Premiumqualität besteht aus verleimten Massivholzstreifen unterschiedlicher Breite, die mit mit Öl, N-Lack (matt-naturell) oder P-Lack (Projektack bzw. Seidenglanz) behandelt werden. Astlöcher, Verwachsungen und schwarze Stellen gibt es in der Arco-Premiumqualität zwar, sie sind jedoch niemals sichtbar und können beispielsweise auf der Unterseite einer Tischplatte auftreten.

SEMI-SOLID:

DURAMAS



Duramas is composed of a thin layer of premium-quality solid wood bonded to the top and underside of a supporting core such as poplar, to create a highly stable sandwich construction. This provides an economical use of high-quality wood. The top layer is robust enough to be sanded and re-finished with oil or lacquer.

Duramas is een dunne laag premium quality massief hout dat we verlijmen aan de boven- en onderkant van een dragend kernmateriaal, bijvoorbeeld populier. Zo ontstaat een superstabele sandwichconstructie. En op die manier gaan we heel zuinig om met hoogwaardig hout. De toplaag is stevig genoeg om af te schuren en opnieuw te oliën of te lakken.

Duramas besteht aus einer dünnen Schicht Massivholz in Premiumqualität, das an der Oben- und Unterseite eines tragenden Kernmaterials wie zum Beispiel Pappel verleimt wird. So entsteht eine superstabile Sandwich-Konstruktion. Auf diese Weise wird sparsam mit hochwertigem Holz umgegangen, die oberste Schicht ist jedoch stabil genug, um sie genau wie Massivholz abschleifen und erneut ölen oder lackieren zu können.

VENEER



A veneer is a very thin layer of wood, bonded to a substrate. Veneers are real wood with all of its warm look and feel. But it hardly 'works' (shrinking and expansion). We apply our veneers in mirrored sheets. This creates a visual repetition of the grain ensuring a balanced pattern across the wood's surface.

Fineer is een dun laagje hout dat op een kern van plaatmateriaal wordt gelijmd. Fineer is echt hout, met dezelfde warme uitstraling en hetzelfde gevoel. Maar het werkt nauwelijks, krimpt niet en zet ook niet uit. We gebruiken de vellen fineer gespiegeld. Zo lopen de patronen in het hout optisch door en ontstaat er een gelijkmatig houtbeeld.

Furnier ist eine dünne Holzschicht, die auf einen Kern aus Plattenmaterial geleimt wird. Der Vorteil von Furnier ist, dass es sich um echtes Holz handelt, das dieselbe warme Ausstrahlung und Haptik aufweist, aber kaum „arbeitet“ und nicht schrumpft oder sich ausdehnt. Arco verwendet ein spezielles Verfahren, bei dem die Furnierbögen gespiegelt werden, so dass im Holz durchgängige Muster zu sehen sind und ein gleichmäßiges Holzbild entsteht.

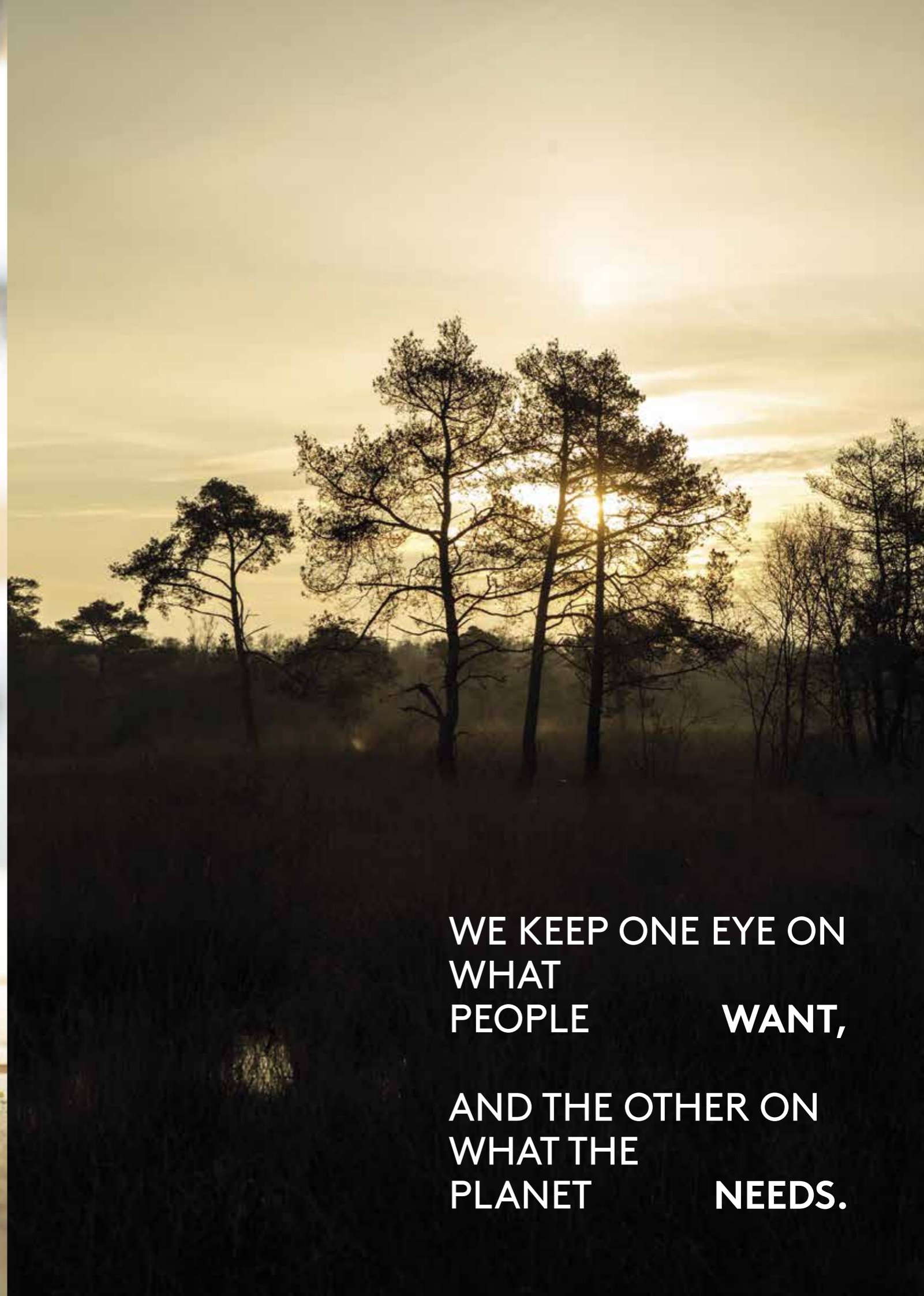

WE KEEP ONE EYE ON
WHAT
PEOPLE WANT,
AND THE OTHER ON
WHAT THE
PLANET NEEDS.

OUR TABLES LAST A LIFETIME.

BAD FOR BUSINESS, GOOD FOR THE PLANET.

We make sustainable choices when possible and our ambition is to do better every year. Above all, it is important to us to be transparent about our products and production. Read more about Product Eco Passports, Refurbishing, Care & Maintenance and other sustainable applications.

Daar waar het kan, maken we duurzame keuzes en we hebben de ambitie dit elk jaar een beetje meer te doen. Bovenal is het voor ons belangrijk transparant te zijn over de producten en productie. Lees meer over Product Eco Passports, Refurbishing, onderhoud en andere duurzame toepassingen.

Wo immer dies möglich ist, treffen wir eine nachhaltige Auswahl und wir sind bestrebt, diese Praxis in jedem Geschäftsjahr weiter zu intensivieren. Uns ist zudem daran gelegen, unsere Produkte und Produktionsverfahren transparent zu gestalten. Erfahren Sie mehr über Product Eco Passports, Refurbishing, Pflege und weitere nachhaltige Einsatzbereiche.



Made in Holland

We are committed to quality and craftsmanship. Our tables are therefore produced by the best craftsmen in our own factory in the Netherlands. Also, our small furniture and most of our chair collection is produced in the Netherlands. And we take pride in that.

We hechten veel belang aan kwaliteit en vakmanschap. Onze tafels worden door de beste vakmensen gemaakt in onze eigen fabriek in Nederland. Ook onze kleinmeubelen en het grootste deel van onze stoelencollectie worden in Nederland gemaakt. En daar zijn we trots op.

Wir haben uns der Qualität und der Handwerkskunst verpflichtet. Unsere Tische werden deshalb von den besten Handwerkern in unserer eigenen Fabrik in den Niederlanden hergestellt. Auch unsere Kleinmöbel und der grösste Teil unserer Stuhlkollektion wird in den Niederlanden produziert. Und wir sind stolz darauf.



Made in Germany

For a small part of our chair collection, we avail ourselves of the knowledge of our neighbors just across the border. Germany is a country known for its high performance and quality.

Voor een deel van onze stoelencollectie maken we gebruik van de kennis van onze burens net over de grens. Duitsland is een land dat bekend staat om zijn vakmanschap en kwaliteit.

Für einen kleinen Teil unserer Stuhlkollektion bedienen wir uns des Wissens unserer Nachbarn jenseits der Grenze. Deutschland ist ein Land, welches für seine hohe Leistung und Qualität bekannt ist.



Refurbish

Our tables are designed in a way that allows them to be refurbished, which creates a new lifecycle. We are able to restore and/or upgrade almost all our existing products. The functionality of the product remains the same, but after a refurbishment in our factory the product looks like new again.

We houden er in onze ontwerpen onder andere rekening mee dat een product te "refurbishen" is. Zo zorgen we voor een nieuwe levenscyclus van het product. Het is mogelijk om bijna al onze producten te herstellen en/of te upgraden. De functionaliteit van het product blijft hetzelfde, maar het product ziet er na een opknapbeurt in onze fabriek weer als nieuw uit.

Bei unseren Designs berücksichtigen wir unter anderem, dass ein Produkt „refurbished“ werden kann. So sichern wir einen neuen Lebenszyklus des Produkts. Es ist möglich, fast alle unsere Produkte zu reparieren und/oder modernisieren. Die Funktion des Produkts bleibt gleich, aber das Produkt sieht nach der Aufarbeitung in unserer Fabrik wieder wie neu aus.



Reduce

Arco aims at reducing the consumption of raw materials during production.

Arco streeft ernaar het verbruik van grondstoffen tijdens de productie te verminderen.

Arco strebt danach, den Verbrauch von Rohstoffen bei der Produktion zu reduzieren.



Repair

Please contact your dealer in case repair of Arco your product is needed.

Neem contact op met je dealer als je Arco product gerepareerd moet worden.

Wenden Sie sich bitte an Ihren Händler, falls Ihr Arco-Produkt repariert werden muss.



Recycle

We develop our products in such a way that they can be easily



Arco lightweight

We use as much lightweight materials in the product as possible, avoiding unnecessary weight. This allows the most effective use of energy sources both in terms of transport and processing by people.

We gebruiken zoveel mogelijk lichtgewicht materialen in onze producten, zodat onnodig gewicht vermeden wordt. Dit maakt een zo efficiënt mogelijk gebruik van energiebronnen mogelijk, zowel bij het vervoer als bij de latere verwerking bij de klant.

Wir verwenden in den Produkten so viel wie möglich leichte Materialien, um unnötiges Gewicht zu vermeiden. Dies ermöglicht die effektivste Nutzung von Energieressourcen, sowohl für den Transport als auch für die Verarbeitung durch den Menschen.

disassembled at the end of their service life. This will ensure that the various materials are highly recyclable.

Wij ontwikkelen onze producten zodanig dat ze aan het eind van hun levensduur gemakkelijk gedemonteerd kunnen worden. Dit zorgt ervoor dat de verschillende materialen in hoge mate recyclebaar zijn.

Wir entwickeln unsere Produkte so, dass sie am Ende ihrer Lebensdauer einfach auseinander gebaut werden können. So wird sichergestellt, dass die verschiedenen Materialien in hohem Masse recycelbar sind.



Arco flatpack

The packaging is made, whenever possible, as flat as possible so it takes up less volume, resulting in less transport on an annual basis.

De verpakking van onze producten is altijd zo plat mogelijk, zodat ze minder volume innemen. Op jaarbasis levert dit dus een stuk minder transport op.

Die Verpackungen sind, wann immer möglich, so flach wie möglich gehalten, sodass sie weniger Platz beanspruchen und somit weniger Transporte pro Jahr anfallen.



Arco Duramas

These table tops have a core of less scarce wood species, with a solid wooden layer glued at the top and bottom. Through this method scarce solid wood is efficiently dealt with, without compromising on quality.

De duramas tafelbladen hebben een kern van snelgroeiende en minder schaarse houtsoorten, die vervolgens aan de boven- en onderzijde voorzien wordt van een laag massief hout. Met deze methode wordt schaars massief hout efficiënt gebruikt, zonder aan kwaliteit in te boeten.

Diese Tischplatten haben einen Kern aus weniger seltenen, schnell nachwachsenden Holzarten, der oben und unten mit einer Massivholzschicht verleimt ist. Durch diese Methode wird knappes Massivholz effizient genutzt, ohne dass die Qualität darunter leidet.



Arco Local Wood

With the Local Wood collection, we maintain the production chain as short as possible. The collection is produced by local parties: from raw materials and processing (sawing and drying) to production. All the wood for this collection comes from the immediate vicinity of our plant in Winterswijk: the Netherlands and West Germany. This saves a lot of kilometres and thus a lot of energy.

Met de Local Wood-collectie houden we de productieketen zo kort mogelijk. De collectie wordt door plaatselijke partijen gemaakt: van grondstof (hout) en verwerking (zagen en drogen) tot productie. Al het hout voor deze collectie komt uit de omgeving van onze fabriek in Winterswijk: deels uit Nederland en deels uit West-Duitsland. Dit bespaart veel kilometers en dus veel energie.

Mit der Local-Wood-Kollektion halten wir die Produktionskette so kurz wie möglich. Die Kollektion wird von lokalen Parteien hergestellt: vom Rohmaterial über die Verarbeitung (Sägen und Trocknen) bis zur Produktion. Das gesamte Holz für diese Kollektion stammt aus der unmittelbaren Umgebung unseres Werks in Winterswijk: nämlich aus den Niederlanden und Westdeutschland. Das spart viele Kilometer und damit eine Menge Energie.

Product Eco Passport



A growing number of people are rightly asking for the origin of products and the composition of the materials of a product. As we wish to be as transparent as possible on these matters, all of our products are provided with a Product Eco Passport. This is a clear overview of the product, with the composition of the materials and their percentages by weight.

Steeds meer mensen vragen - terecht - naar de herkomst van producten en naar de samenstelling van materialen in een product. Omdat wij hier zo transparant mogelijk over willen zijn, is elk product voorzien van een "Product Eco Passport": een duidelijk overzicht van de materiaalsamenstelling met gewichtspercentages van ieder product.

Immer mehr Menschen fragen zu Recht nach der Herkunft von Produkten und der Zusammensetzung von Materialien in einem Produkt. Weil wir hier so transparent wie möglich sein möchten, ist jedes Produkt mit einem "Product Eco Passport" versehen: ein klarer Überblick über die Materialzusammensetzung und deren Gewichtsanteile eines Produkts.



product

Laze

designer

**Gudmundur
Ludvik**

year

2019

PRODUCT ECO PASSPORT

MATERIALS

(percentage by weight)

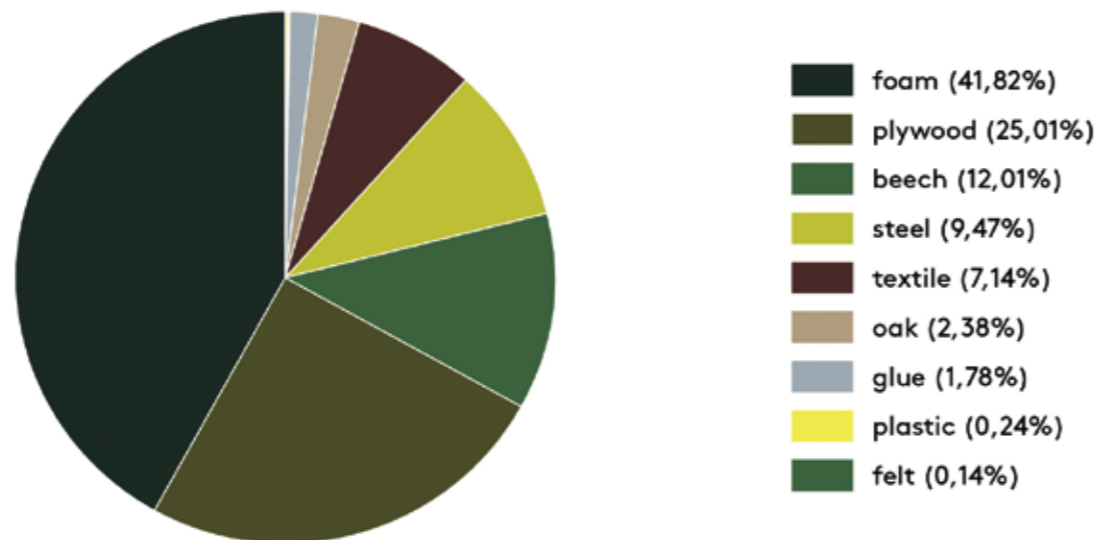

Based on: Laze | 8 kg

CERTIFICATES

Within Arco's leather collection there are Reach or Blaue Engel certified leathers. Our fabric suppliers also offer a wide range of certified fabrics.

SUSTAINABLE FEATURES

recycle repair made in Germany

The chairs of the Arco collection can be re-upholstered and certain components can be replaced.

PACKAGING & LOGISTICS

Our packaging is produced by means of an "on-demand packaging machine". The packaging is exactly tailored for each product, using a minimal amount of packaging material. Moreover, in this way the product is optimally packed and well protected during transport. The carriers that collaborate with Arco give, just as Arco, high priority to durability. They aim at reducing the CO2-emissions through, among others, the use of cleaner engines (EURO VI), the effort in reducing fuel consumption, optimizing the loading space and optimal planning.

WARRANTY

All Arco furniture is made with exceptionally high-quality materials and produced with the greatest possible care. If, despite this, something goes wrong, we will of course be happy to resolve the problem professionally. Arco furniture is guaranteed for 5 years. Please visit our website www.arco.nl to read the guarantee conditions.



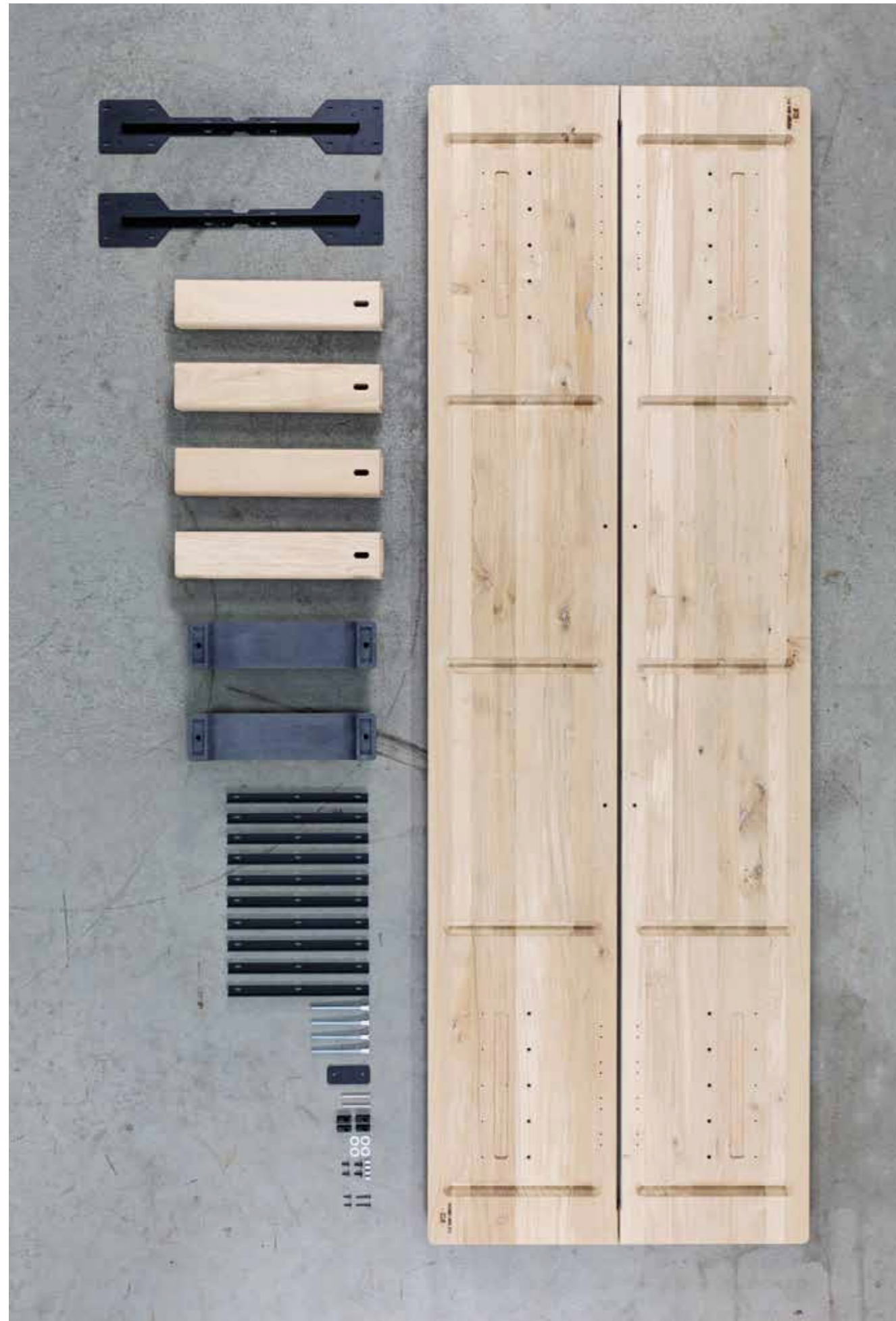

PASS IT ON: NEW HOMES FOR OLD TABLES



Arco believes in circularity and circular principles. Alongside wanting to make beautiful products, it is at least as important to us that they are durable. Quality is thereby key. Our tables are designed to last for generations. To make memories for life.

Our tables are designed in a way that allows them to be refurbished, which creates a new lifecycle. We are able to restore and/or upgrade almost all our existing products.

By refurbishing a product, we do not waste resources unnecessarily. The functionality of the product remains the same, but after a refurbishment in our factory the product looks like new again. The product gets a second life, ready for even more beautiful moments.



Arco gelooft in circulariteit en circulaire principes. Naast dat we mooie producten willen maken, is het minstens zo belangrijk dat ze duurzaam zijn. Kwaliteit is hierbij key. Onze tafels zijn er om generaties lang mee te gaan. Om herinneringen aan te maken voor het leven.

We houden er in onze ontwerpen onder andere rekening mee dat een product te "refurbishen" is. Zo zorgen we voor een nieuwe levenscyclus van het product. Het is mogelijk om bijna al onze producten te herstellen en/of te upgraden. Het liefst hergebruiken we alle onderdelen, maar als het echt nodig is, dan zullen we bepaalde componenten uiteraard vervangen. Door het refurbishen van onze producten, verspillen we niet onnodig grondstoffen. De functionaliteit van het product blijft hetzelfde, maar het product ziet er na een opknapbeurt in onze fabriek weer als nieuw uit. Het product krijgt een tweede leven, klaar voor nog meer mooie momenten.

Arco glaubt an Kreislaufwirtschaft und zirkuläre Prinzipien. Abgesehen von der Tatsache, dass wir schöne Produkte herstellen möchten, ist es mindestens genauso wichtig, dass diese nachhaltig sind. Qualität ist dabei entscheidend. Unsere Tische sollen Generationen überdauern. Sie sollen lebenslange Erinnerungen erschaffen.

Bei unseren Designs berücksichtigen wir unter anderem, dass ein Produkt „refurbished“ werden kann. So sichern wir einen neuen Lebenszyklus des Produkts. Es ist möglich, fast alle unsere Produkte zu reparieren und/oder modernisieren. Am liebsten verwenden wir alle Teile wieder, aber wenn es wirklich erforderlich ist, werden wir natürlich bestimmte Komponenten ersetzen. Durch die Aufarbeitung unserer Produkte verschenden wir keine Rohstoffe. Die Funktion des Produkts bleibt gleich, aber das Produkt sieht nach der Aufarbeitung in unserer Fabrik wieder wie neu aus. Das Produkt erhält ein zweites Leben, bereit für viele weitere schöne Momente.



Before

After

LOVE AND RESPECT. THE KEY TO ANY LONG TERM RELATIONSHIP.

The more you care for your belongings, the longer they last. Which makes sense for you, your wallet, and the environment. And if you're planning to pass it on to the next generation, you'll be doing them a favour too.

Of course, our furniture is designed to last, but even so: it could use a little help. On our website, you'll find straightforward tips to extend its lifespan.

Hoe meer zorg en liefde je besteedt aan je Arco product(en) hoe langer deze mee gaat. Goed voor jou, je portemonnee en de planeet. En, mocht je van plan zijn je meubel door te geven aan de volgende generatie, dan doe je ook hen een plezier.

Natuurlijk zijn onze meubelen ontworpen om lang mee te gaan, maar toch: ze kunnen wat hulp gebruiken. Op onze website vindt u eenvoudige tips om de levensduur te verlengen.

Je besser Sie Ihren Möbel pflegen, desto länger werden Sie Freude an ihm haben. Das ist gut für Sie, Ihre Brieftasche und die Umwelt. Und falls Sie vorhaben, es an die nächste Generation zu übergeben, tun Sie auch dieser damit einen Gefallen.

Denn auch wenn unsere Möbel natürlich auf Langlebigkeit ausgelegt sind, können sie ein wenig Pflege gebrauchen. Auf www.arco.nl finden Sie konkrete Hinweise, wie sie ihre Lebenszeit verlängern können.

Perhaps take a few minutes to study this advice over a cup of tea. Scan the QR-code on the left or visit www.arco.nl.

Neemt u even de tijd om deze adviezen te bestuderen bij een kopje thee. Scan de QR-code links of kijk op www.arco.nl.

Lesen Sie sich die Pflegehinweise in Ruhe durch. Scannen Sie den QR-Code auf der linken Seite oder besuchen Sie www.arco.nl.

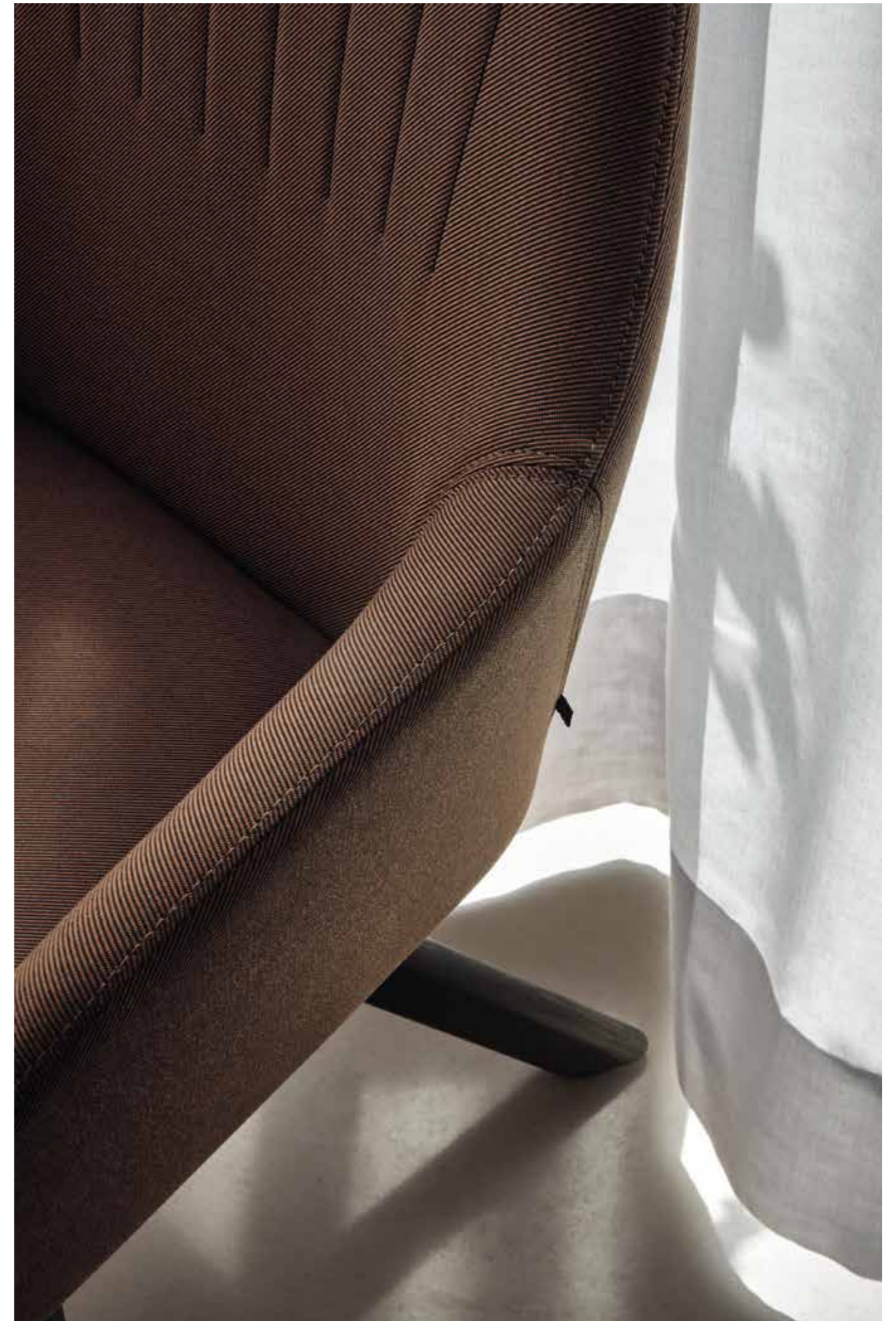



WE SEARCHED
EVERYWHERE
FOR THE
BEST WOOD.

TURNS OUT
IT WAS
NEXT DOOR
ALL ALONG.

PROJECTS

The modern office is a space where meetings, informal briefings and individual work alternate constantly. A new way of working and a new generation of workers require new office environments and products. At the same time lobby, reception and meeting areas need to be more flexible.

Arco provides informal, flexible solutions for different work moments, environments and situations in today's workplace. For various projects – national and international – Arco delivered furniture suitable for the environment, space and situation.

PROJECTEN

In de huidige werkomgeving wisselen vergaderen, informeel overleg en individueel werk zich steeds sneller af. Nieuwe werkmethoden – het nieuwe werken – en een nieuwe generatie werknemers vereisen een nieuw soort werkplek en producten. Ook wacht-, ontvangst- en ontmoetingsruimten moeten tegenwoordig steeds flexibeler zijn.

Arco geeft hier een geheel eigen invulling aan: informele, flexibele maatwerkoplossingen voor verschillende werkmomenten, plaatsen en situaties op de hedendaagse werkvloer. Voor verschillende projecten – nationaal én internationaal – heeft Arco de meubelen geleverd passend voor de omgeving, ruimte en situatie.

PROJEKTE

In der heutigen Arbeitswelt wechseln sich Konferenzen, informelle Besprechungen und individuelle Arbeit sich immer schneller ab. Neue Arbeitsweisen – das neue Arbeiten – und eine neue Generation von Arbeitnehmern erfordern eine neue Art Arbeitsplatz. Auch Warte-, Empfangs- und Versammlungsräume müssen immer flexibeler sein.

Arco hat seine eigene Ideen zum Thema „neues Arbeiten“: informelle, flexible, kundenspezifische Lösungen für unterschiedliche Arbeitssituationen in der heutigen Arbeitswelt. Für unterschiedliche Projekte hat Arco Möbel geliefert speziell geeignet für die Umgebung, Raum und Situation.



Project
Spaces
Copenhagen, Denmark

Architect
Sevil Peach

Products
Slim (table)
Slim+ (table)
Slim+ High (table)

Photography
Jordi Huisman



Project
Frederiksplein 1, Amsterdam

Architect
Office Winhov

Products
Slim (table)
Kami (table)
Balance (table)

Photography
Max Hart Nibbrig

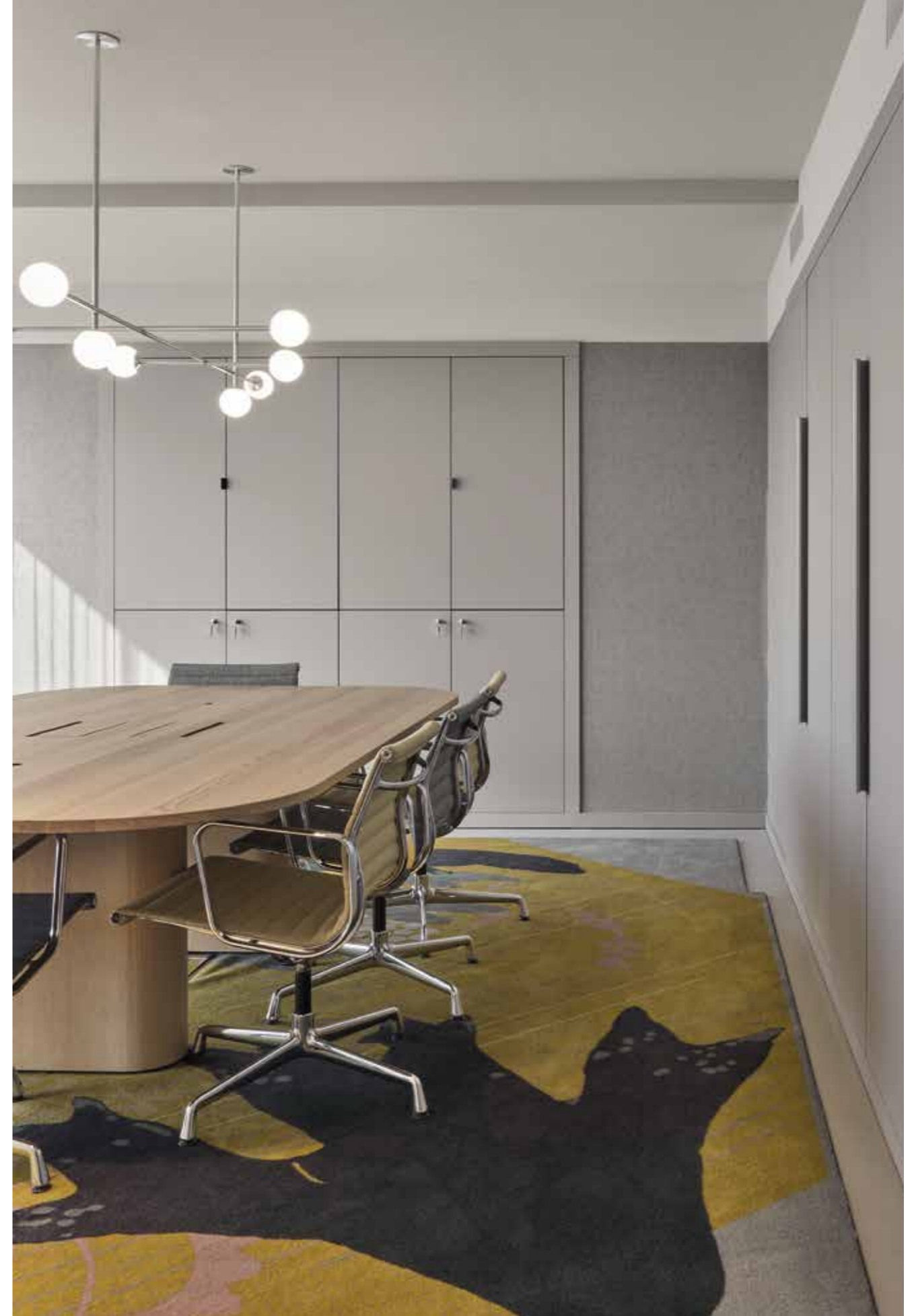



Project
MDC Venture
San Francisco, USA

Architect
Feldman Architecture

Products
Grid Work Regular (table)
Ease (chair)

Photography
Paul Dyer



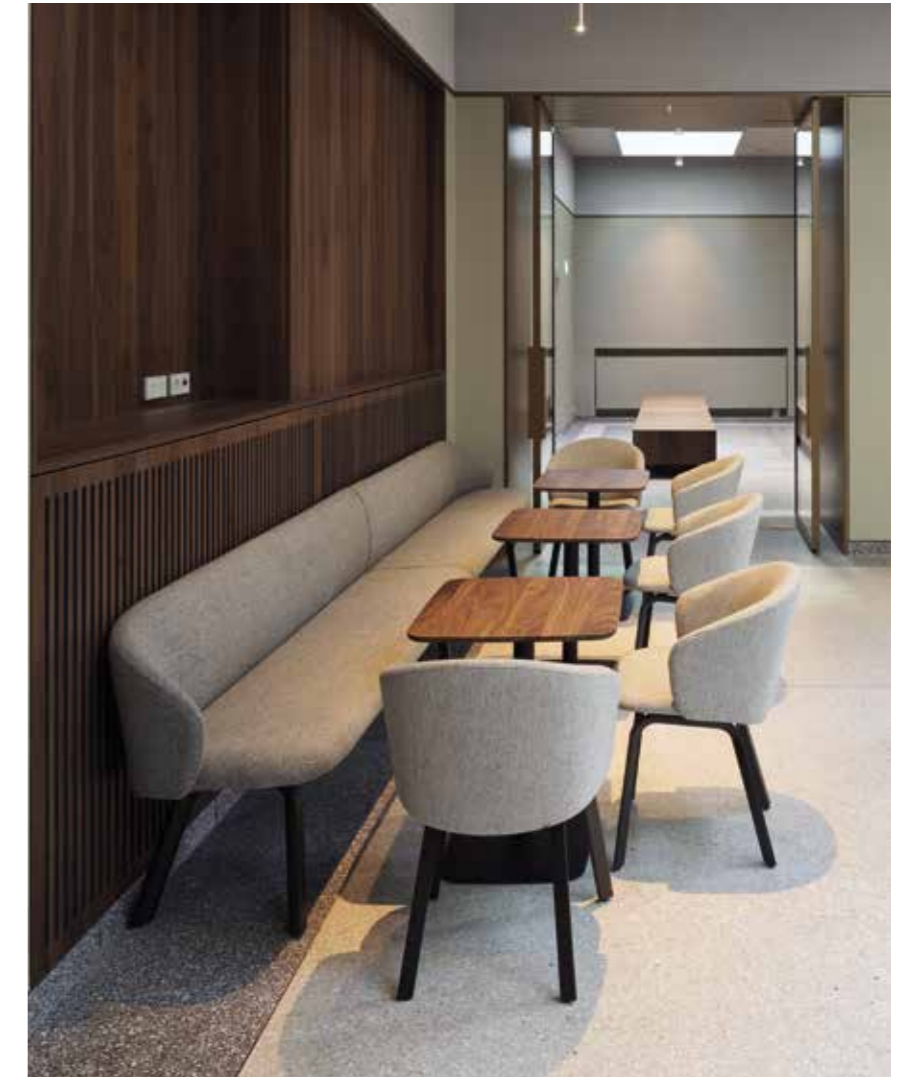

Project
 Koninklijke Nederlandse Akademie
 van Wetenschappen
 Amsterdam, the Netherlands

Architect
 Office Winhov

Products
 Essenza (table)
 Slim (table)
 Close (chair)
 Close Bench
 Side by Side (sofa)

Photography
 Max Hart Nibbrig
 René de Wit



Project
 Royal Opera House
 London, United Kingdom

Architect
 Studio Linse

Products
 Slim (table)
 Slim+ (table)
 Slim+ High (table)

Photography
 Luke Hayes



Project
HofmanDujardin Office Villa
Diemen, the Netherlands

Architect
Hofman Dujardin

Products
Grid Regular (table)
Close (chair)

Photography
Matthijs van Roon



Project
Town Hall Amsterdam
Amsterdam, the Netherlands

Architect
De Twee Snoeken, Zwartwoud

Products
Sketch Work High (chair)

Photography
Zwartwoud



Project
 Villa Fifty Fifty
 Eindhoven, the Netherlands

Architect
 studioninedots

Products
 Base (table)

Photography
 Frans Parthesius

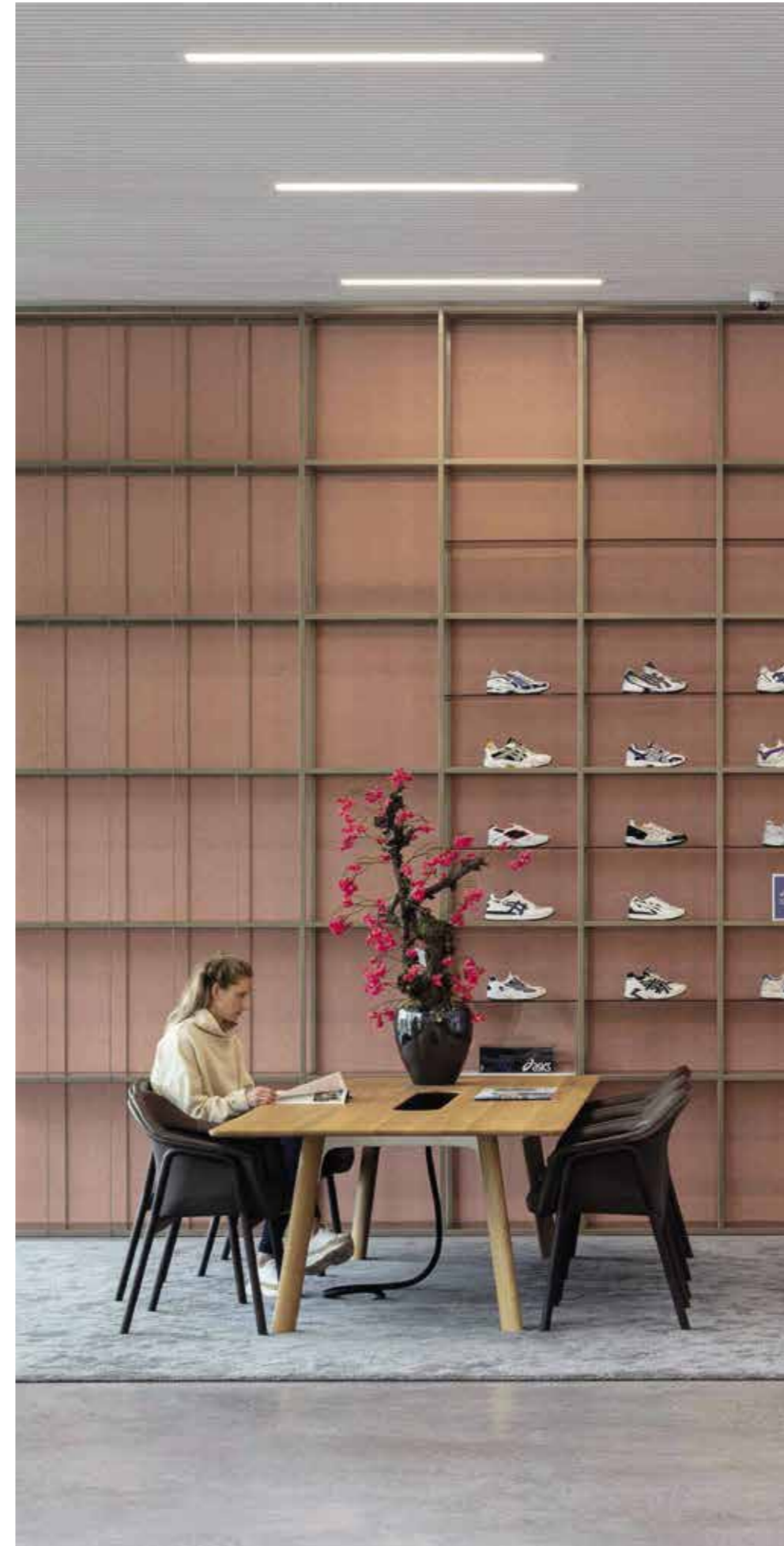

Project
 ASICS Headquarters
 Hoofddorp, the Netherlands

Architect
 CBRE

Products
 Grid Rectangular (table)

Photography
 Stijnsstijl

Tailoring

Every person has individual desires and needs and every room needs a different approach. Therefore, it is only logical that almost all our tables can be adapted according to your wishes and requirements: to the appropriate length, width and height and with the desired finish. In this way, we create tables suitable for every situation: the interior of an office, a living room, a table for a family with young children or a comfortable conference table for hours of debating if necessary. Our skillfully crafted, high quality products are made with great passion. In doing so, we make sure you will enjoy your table for years on end.

It is only logical that almost all our tables can be adapted according to your wishes & requirements: to the appropriate length, width and height and with the desired finish.

For tailoring see 2b in the factsheets



Ieder mens heeft andere wensen en behoeftes en iedere ruimte vraagt om een andere invulling. Het is dan ook niet meer dan logisch dat bijna al onze tafels zijn aan te passen aan de behoeftes en wensen van onze klant: met de juiste lengte, breedte, hoogte en afwerking. Zo creëren we tafels die geschikt zijn voor iedere situatie: of het nu gaat om de inrichting van een groot kantoor of een woon- kamer, een tafel geschikt voor een gezin met jonge kinderen of een tafel voorzien van alle gemakken voor uren- lang vergaderen. Onze tafels zijn ambachts- producten die met veel aandacht en kwaliteit worden gemaakt zodat u er jarenlang van kunt genieten.

Het is dan ook niet meer dan logisch dat bijna al onze tafels zijn aan te passen aan deze behoeftes en wensen van onze klant: met de juiste lengte, breedte, hoogte en afwerking.

Voor tailoring zie punt 2b in de factsheets



Jeder Mensch hat andere Wünsche und Bedürfnisse und jeder Raum benötigt eine andere Gestaltung. Deshalb ist es auch nicht mehr als logisch, dass fast alle unsere Tische an diese Bedürfnisse und Wünsche des Kunden angepasst werden können: mit der richtigen Länge, Breite, Höhe und Oberfläche. So schaffen wir Tische, die sich für jede Situation eignen: ob es nun um die Einrichtung eines großen Büros oder eines Wohnzimmers geht, um einen Tisch, der sich für eine Familie mit jungen Kindern eignet, oder einen Tisch, der mit allem Komfort für stunden- lange Konferenzen ausgestattet ist. Unsere Tische sind hand- werkliche Produkte, die mit viel Sorgfalt und Qualität hergestellt wurden, so dass Sie viele Jahre lang Spaß daran haben können.

Deshalb ist es auch mehr als logisch, dass fast alle unsere Tische an diese Bedürfnisse und Wünsche des Kunden angepasst werden können: mit der richtigen Länge, Breite, Höhe und Oberfläche.

Für Tailoring siehe Punkt 2b in Factsheet



**BEAUTY
DOESN'T
SHOUT.**

Get in touch



Arco is represented by sales agents, together with a network of carefully selected dealers they are there to assist you with your inquiries.

Please scan the QR-code below or visit our website www.arco.nl for a complete listing of our agents and dealers.



Sales manager Contract International
Jane Wolf
j.wolf@arco.nl

Sales manager Contract Benelux
Alice Bezemer
a.bezemer@arco.nl

Sales manager Retail
Agerta Bokking
a.bokking@arco.nl

For daily operational sales management (all product requests, PO's, invoices, daily operational matters) please contact:

For contract: project@arco.nl
For retail: wonen@arco.nl

Visit us

On our website www.arco.nl you'll find additional product information, Product Eco Passports, images and 3D files as download.

Our collection can also be found in the **pCon catalogue** and **Architonic product library**.



Showrooms

Design Post Amsterdam
Cruquiusweg 111 M
1019 AG Amsterdam
+31 (0)20 599 6420
www.designpostamsterdam.nl
info@designpostamsterdam.nl

Design Post Köln
Deutz-Mülheimer-Str. 22a
50679 Cologne
+49 221 690 650
www.designpost.de
info@designpost.de

Favourized Space Berlin
Grainauer Straße 11
10777 Berlin
www.favourized.com
Please note: this showroom is open by appointment only



we love wood

Kottenseweg, Winterswijk
N 51.56.565, E 6.46.707

OFFICE,
SCHOOL,
RESTAURANT.

REMEMBER
WHEN TABLES
WERE JUST
TABLES?





Table shapes

- Square
- Round
- △ Triangle
- ▭ Rectangular
- ◌ Ellipse
- ◌ Oval
- ▭ Barrel
- ◌ Organic
- ▭ Connected
- ▭ Extendable

overview Tables



Balance Round

p. 72

Balance Round
Balance Ellipse

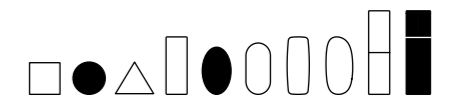

Base (Local Wood)

p. 76

Base
Base Bench



Cast (Local Wood)

p. 80

Cast



Dew

p. 84

Dew





Essential

p. 90

Essential



Joist Ellipse

p. 110

Joist Round
Joist Ellipse

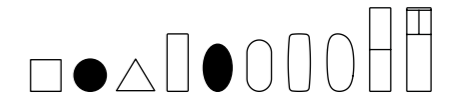

Essenza en Essenza Bench

p. 94

Essenza
Essenza Bench
Essenza XL



Kami Oval 2

p. 114

Kami Round
Kami Oval 1
(oval base)
Kami Oval 2
(round base)



Grid High

p. 98

Grid Rectangular
Grid Barrel
Grid High
Grid Round



Move

p. 118

Move



HAT

p. 106

HAT



Shift

p. 124

Shift





Slim

p. 128

Slim Square
Slim Rectangular
Slim Bench
Slim Flex



Slim+ & Slim+ Bench

p. 134

Slim+ Rectangular
Slim+ High
Slim+ Bench
Slim+ Flex
Slim+ Round
Slim+ Connected



Spazio Conference

p. 140

Spazio

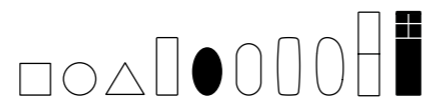

Trestle (Local Wood)

p. 142

Trestle



we (re)think details



product

Balance

designer

**Arnold
Merckx**

year

1988



Balance is a practical dining or conference table. The table is available as a fixed or extendable table with a wide range of finishes.

Balance is een praktische eet- of vergadertafel. De tafel is leverbaar als vaste en als uitschuifbare tafel en is verkrijgbaar in vele uitvoeringen.

Balance ist einer praktischen Esch- oder Konferenztisch. Der Tisch ist als fester Tisch und als ausziehbarer Tisch lieferbar und in vielen Ausführungen erhältlich.



product

designer

year

1 **Balance**

**Arnold
Merckx**

1988

2a **Standard**

Balance round 1

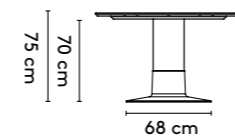
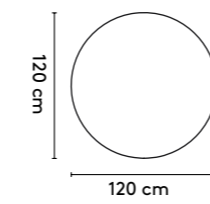

Ø 120 x 75 cm
Ø 128 x 75 cm
Ø 136 x 75 cm

Balance round 2

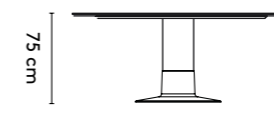
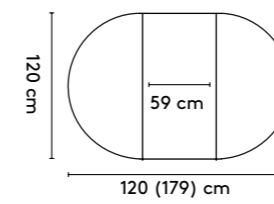

Ø 120 (179) x 75 cm
Ø 130 (189) x 75 cm

Balance ellipse 1

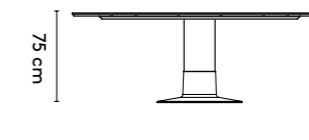
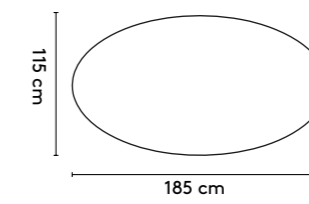

Ø 185 x 115 x 75 cm
Ø 210 x 115 x 75 cm

Balance ellipse 2

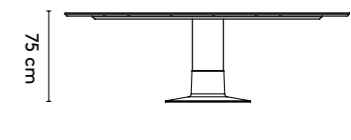
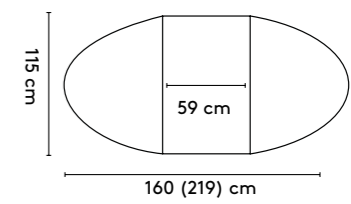

Ø 160 (219) x 115 x 75 cm

2b **Tailoring**

Balance round 1

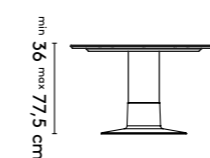
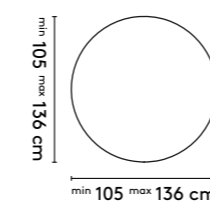

Balance ellipse 1

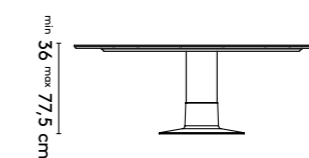
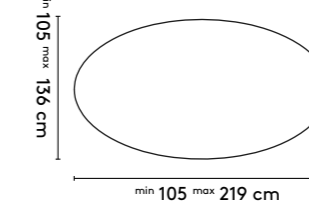

3 **Materials**

Top: oak or walnut (solid, veneer, duramas), oak smoked (solid), Fenix® HPL
Extension leaf: oak or walnut (veneer, duramas), Fenix® HPL
Column: oak or walnut (veneer), color lacquer on multiplex
Base: epoxy fine texture on aluminum, brushed aluminium

Materialen

Blad: eiken of noten (massief, fineer, duramas), gerookt eiken (massief), Fenix® HPL
Uitschuifblad: eiken of noten (fineer, duramas), Fenix® HPL
Kolon: eiken of noten (fineer), kleurlak op multiplex
Voet: epoxy fine texture op aluminium, aluminium geborsteld

Materialien

Platte: Eiche oder Nussbaum (Massiv, Furnier, Duramas), Eiche geräuchert (Massiv), Fenix® HPL
Einlegeplatte: Eiche oder Nussbaum (Furnier, Duramas), Fenix® HPL
Säule: Eiche oder Nussbaum (Furnier), Farblack auf Multiplex
Fuss: Epoxy fine texture auf Aluminium, gebürstetes Aluminium

4 **Finishes**

All Arco colors and finishes for the mentioned materials

Afwerkingen

Alle Arco kleuren en (lak)afwerkingen voor de genoemde materialen

Ausführungen

Alle Arco Farben und Ausführungen für die genannten Materialien

5 **Additional information**

-

Aanvullende informatie

-

Weitere Informationen

-

6 **Cable management**

-



The Local Wood collection is made of local wood and concrete: sustainable materials that can take a knock or two.

De producten uit de Local Wood collectie zijn gemaakt van lokaal hout in combinatie met beton; duurzame materialen die tegen een stootje kunnen.

Die Möbel aus unserer Local-Wood-Kollektion sind aus lokalem Holz und Beton; nachhaltige Materialien, die einiges aushalten können.

product

Base

designer

Jorre van Ast

year

2013 - 2016



1 **Base**Jorre
van Ast

2013 - 2016

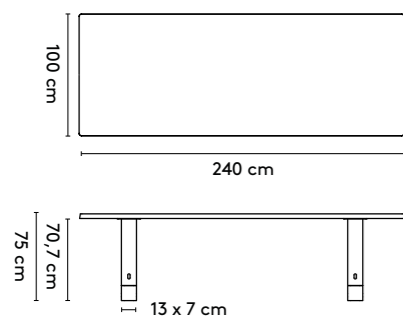
2a **Standard**Base 1 rectangular (thickened 2x20 mm)

240 x 100 x 75 cm (between legs 167 cm)
 280 x 100/120 x 75 cm (between legs 187 cm)
 320 x 105/120 x 75 cm (between legs 207 cm)
 360 x 105/120 x 75 cm (between legs 227 cm)

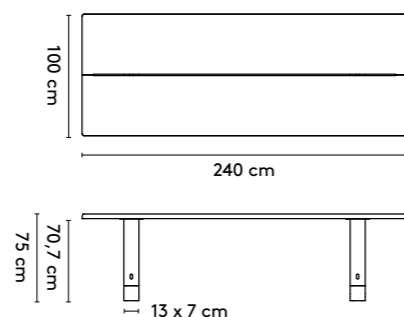
Base 2 rectangular (solid)

240 x 100 x 75 cm (between legs 170/150/130/110 cm)
 280 x 100/120 x 75 cm (between legs 210/190/170/150 cm)
 320 x 105/120 x 75 cm (between legs 250/230/210/190 cm)
 360 x 105/120 x 75 cm (between legs 230 cm)

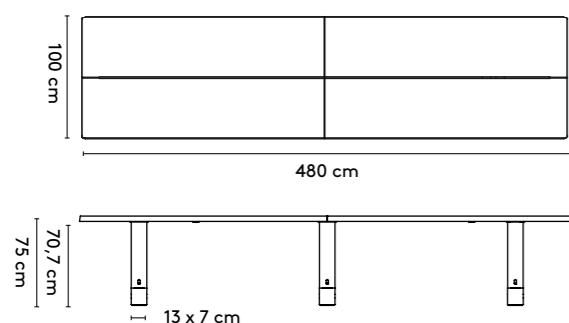
Base 2 rectangular connected

480 x 100 x 75 cm (between legs 192/182/172/162 cm)
 560 x 100 x 75 cm (between legs 232/222/212/202 cm)
 560 x 120 x 75 cm (between legs 232/222/212/202 cm)

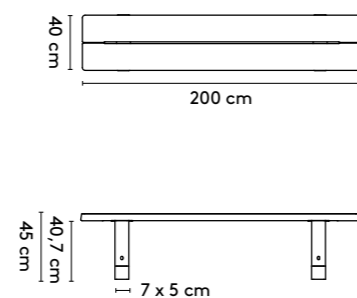
Base bench

200 x 40 x 45 cm
 240 x 40 x 45 cm
 280 x 40 x 45 cm
 320 x 40 x 45 cm

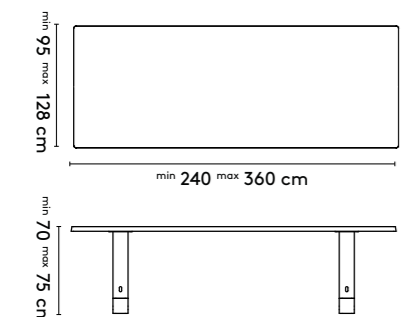
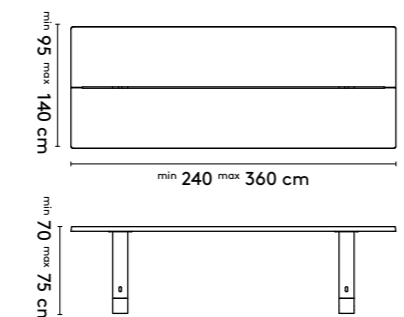
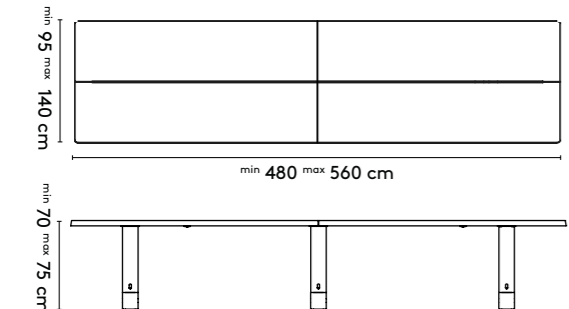
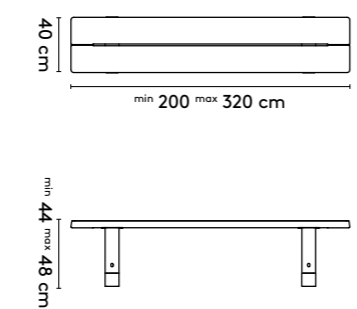
2b **Tailoring**Base rectangular 1 (thickened)Base rectangular 2 (solid)Base rectangular 2 connectedBase bench1 **Base**Jorre
van Ast

2013 - 2016

3 **Materials**

Top: oak (solid, local wood) or walnut (solid), oak smoked (solid)
Legs: oak (solid, local wood), walnut (solid), oak smoked (solid)
Base: concrete (natural, color laquer)

Materialen

Blad: eiken (massief, lokaal hout) of noten (massief), eiken gerookt (massief)
 Onderstel: eiken (massief, lokaal hout), noten (massief), eiken gerookt (massief)
 Voet: beton (natural, kleurlak)

Materialien

Platte: Eiche (Massiv, lokales Holz) oder Nussbaum (Massiv), Eiche geräuchert (Massiv)
 Untergestell: Eiche (Massiv, lokales Holz), Nussbaum (Massiv), Eiche geräuchert (Massiv)
 Fuss: Beton (natural, farblack)

4 **Finishes**

All Arco colors and finishes for the mentioned materials

Afwerkingen

Alle Arco kleuren en (lak)afwerkingen voor de genoemde materialen

Ausführungen

Alle Arco Farben und Ausführungen für die genannten Materialien

5 **Additional information**

Legs can be mounted at 22, 32, 42 or 52 cm from the short side of the table.
 Legs can be mounted at 52 cm only for size 360 cm

Aanvullende informatie

Onderstel kan worden gemonteerd op 22, 32, 42 of 52 cm van de korte zijde van de tafel
 Onderstel kan bij 360 cm alleen op 52 cm worden gemonteerd

Weitere Informationen

Untergestell kann auf 22, 32, 42 oder 52 cm der kurze Seite des Tisches montiert werden
 Untergestell kann bei 360 cm nur auf 52 cm montiert werden

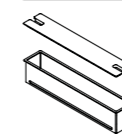
6 **Cable management**

CM06/CM07
epoxy
30/50 cm



CM15
EVOline® One spot
Ø 5,9 cm



CM08/CM09
cable-net
small/large

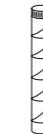

CM12
cable sock
large



CM13
zipper sock
short

product

Cast

designer

**Jorre
van Ast**

year

2019



Continuing Arco's experiments with tradition, the Cast table uses recycled aluminium to form a robust base for its table top of 100% PEFC certified solid oak.

De Cast-tafel, een voortzetting van Arco's experimenten met traditie, maakt gebruik van gerecycled aluminium dat de robuuste basis vormt voor een tafelblad van 100% PEFC-gecertificeerd massief eiken.

Im Sinne des Experimentierens mit Traditionen besteht das robuste Tischgestell des Cast-Tisches aus recyceltem Aluminium und die Tischplatte aus 100% PEFC-zertifizierter, massiver Eiche.



1 **Cast****Jorre
van Ast**

2019

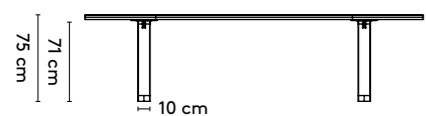
2a **Standard**Cast rectangular 1 (thickened 2x20 mm)

210 x 95 x 75 cm (between legs: 140 cm)
 240 x 100 x 75 cm (between legs: 170 cm)
 280 x 100 x 75 cm (between legs: 190 cm)
 320 x 105 x 75 cm (between legs: 210 cm)
 360 x 105 x 75 cm (between legs: 230 cm)

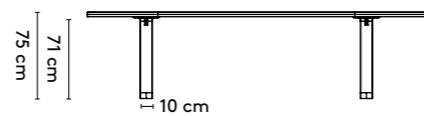
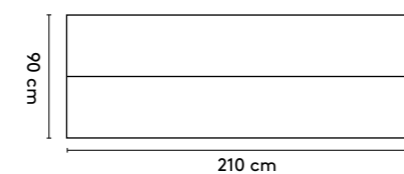
Cast rectangular 2 (solid)

210 x 95 x 75 cm (between legs: 150/130/110cm)
 240 x 100 x 75 cm (between legs: 180/160/140cm)
 280 x 100 x 75 cm (between legs: 220/200/180cm)
 320 x 105 x 75 cm (between legs: 260/240/220cm)
 360 x 105 x 75 cm (between legs: 230cm)

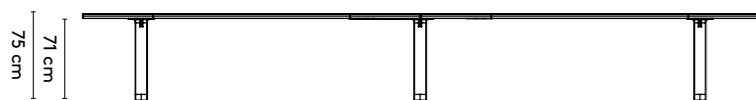
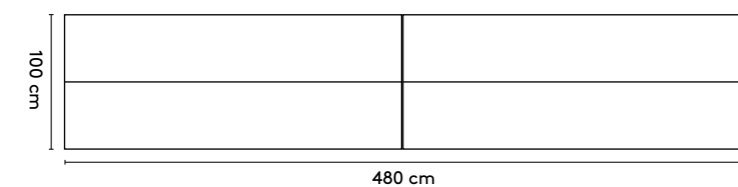
Cast rectangular 2 connected

480 x 100 x 75 cm (between legs: 195/185/175 cm)
 560 x 100 x 75 cm (between legs: 235/225/215 cm)

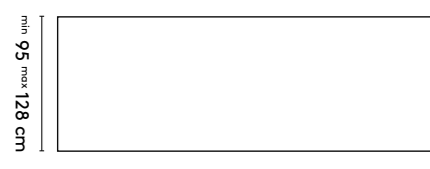
2b **Tailoring**Cast rectangular 1 (thickened 2x20 mm)

min 210 max 360 cm

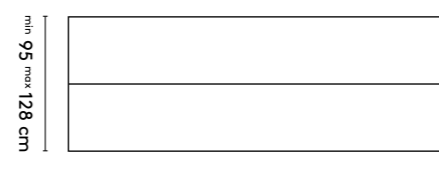
Cast rectangular 2 (solid)

min 210 max 360 cm

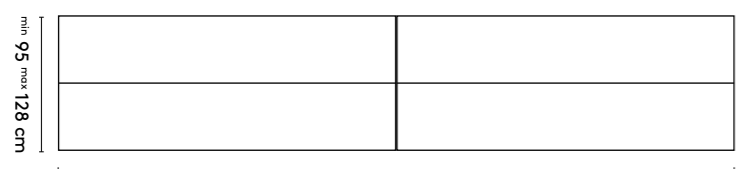
Cast rectangular 2 connected

min 480 max 560 cm

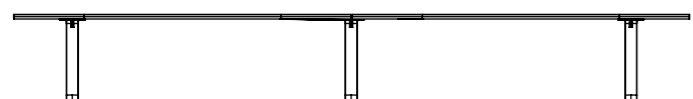
1 **Cast****Jorre
van Ast**

2019

3 **Materials**

Top: oak (solid, local wood) or walnut (solid), oak smoked (solid)
Legs: epoxy fine texture on aluminum

Materialen

Blad: eiken (massief, lokaal hout) of noten (massief), eiken gerookt (massief)
 Onderstel: epoxy fine texture op aluminium

Materialien

Platte: Eiche (Massiv, lokales Holz) oder Nussbaum (Massiv), Eiche geräuchert (Massiv)
 Untergestell: Epoxy fine texture auf Aluminium

4 **Finishes**

All Arco colors and finishes for the mentioned materials

Afwerkingen

Alle Arco kleuren en (lak)afwerkingen voor de genoemde materialen

Ausführungen

Alle Arco Farben und Ausführungen für die genannten Materialien

5 **Additional information**

Legs can be mounted at 25, 35 or 45 cm from the short side of the table (solid top only)

Aanvullende informatie

Onderstel kan worden gemonteerd op 25, 35 of 45 cm van de korte zijde van de tafel (alleen met massief blad)

Weitere Informationen

Untergestell kann auf 25, 35 und 45 cm der kurze Seite des Tisches montiert werden (nur mit Massive platte)

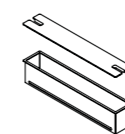
6 **Cable management**

CM06/CM07
epoxy
30/50 cm



CM15
EVOline® One spot
Ø 5,9 cm

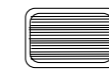

CM08/CM09
cable-net
small/large

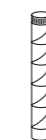

CM12
cable sock
large



CM13
zipper sock
short

product

Dew

designer

**Sabine
Marcelis**

year

2022



Thanks to its striking form, this table never looks out of place. It's available in multiple formats, seating six, eight, or ten people, meaning the Dew can be used as a dining table – but is equally at home in the workplace.

Dankzij de opvallende vorm komt deze tafel overal tot z'n recht. De tafel is leverbaar in verschillende afmetingen, met ruimte voor zes, acht of tien personen. Daarmee is de Dew te gebruiken in de eetkamer, maar ook prima op kantoor.

Dank seiner markanten Form wirkt dieser Tisch nie deplatziert. Der Dew ist in verschiedenen Größen erhältlich und bietet Platz für sechs, acht oder zehn Personen, so dass er als Esstisch verwendet werden kann, sich aber auch gut am Arbeitsplatz macht.



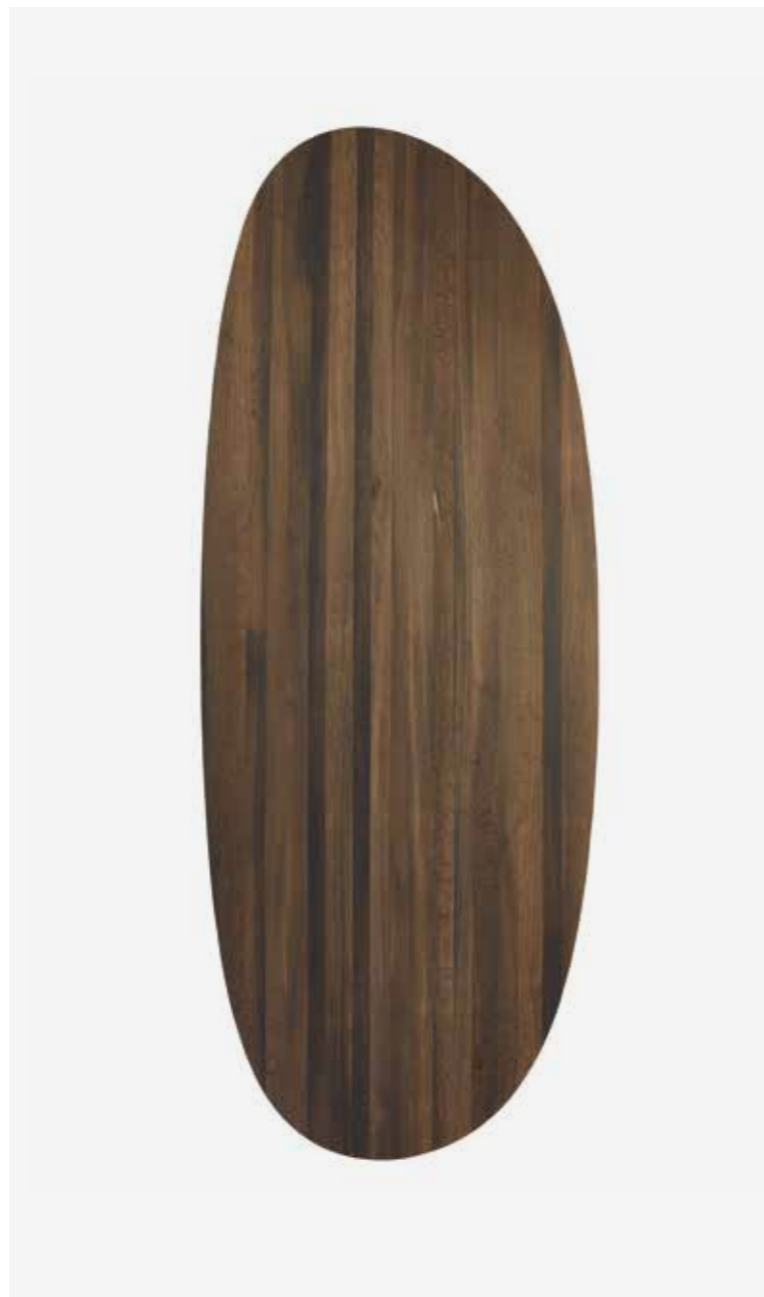

product

1 **Dew**

designer

**Sabine
Marcelis**

year

2022

2 **Standard**

Dew

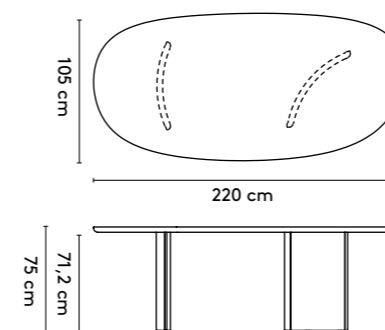

220 x 105 x 75 cm
270 x 115 x 75 cm
330 x 125 x 75 cm

3 **Materials**

**Top: oak or walnut (solid, duramas),
oak smoked (solid, duramas)
Columns: oak or walnut (duramas), oak
smoked (duramas)**

Materialen

Blad: eiken of noten (massief, duramas),
gerookt eiken (massief, duramas)
Wangen: eiken of noten (duramas), gerookt
eiken (duramas)

Materialien

Platte: Eiche oder Nussbaum (Massiv,
Duramas), Eiche geräuchert (Massiv, Duramas)
Säule: Eiche oder Nussbaum (Duramas), Eiche
geräuchert (Duramas)

4 **Finishes**

**All Arco colors and finishes for
the mentioned materials**

Afwerkingen

Alle Arco kleuren en (lak)afwerkingen voor
de genoemde materialen

Ausführungen

Alle Arco Farben und Ausführungen für
die genannten Materialien

5 **Additional information**

-

Aanvullende informatie

-

Weitere Informationen

-

6 **Cable management**



CM15
EVOLINE® One spot
Ø 5,9 cm



product

Essential

designer

Gudmundur
Ludvik

year

2020



The Essential Wood, designed by Gudmundur Ludvik comprises a solid wood tabletop (oak or walnut) on a plywood trestle (beech with oak veneer or walnut veneer). The design combines well with Arco's Close stool.

Deze door Gudmundur Ludvik ontworpen tafel bestaat uit een massief houten tafelblad (eiken of noten) op een plywood onderstel (beuken met eiken- of notenfineer). De tafel kan uitstekend worden gecombineerd met Arco's Close stoel.

Der Essential Wood, entworfen von Gudmundur Ludvik, besteht aus einer Tischplatte aus Massivholz (Eiche oder Walnuss), auf einem Gestell aus Buchen-Laminat, mit einer Eichen- oder Walnuss-Oberbeschichtung.



product

designer

year

1 **Essential**

**Gudmundur
Ludvik**

2020

2 **Standard**

Essential Wood

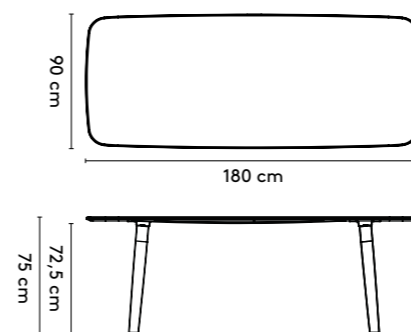

180 x 90 x 75 cm (between legs: 138 cm)
220 x 90 x 75 cm (between legs: 153 cm)
260 x 90 x 75 cm (between legs: 198 cm)

3 **Materials**

**Top: oak or walnut (solid), oak smoked (solid)
Legs: beech laminate with oak or walnut top layer**

Materialen

Blad: eiken of noten (massief), eiken gerookt (massief)
Onderstel: beuken laminaat met eiken of noten toplaag

Materialien

Platte: Eiche oder Nussbaum (Massiv), Eiche geräuchert (Massiv)
Untergestell: Buche Laminat mit Eiche oder Nussbaum Oberbeschichtung

4 **Finishes**

All Arco colors and finishes for the mentioned materials

Afwerkingen

Alle Arco kleuren en (lak)afwerkingen voor de genoemde materialen

Ausführungen

Alle Arco Farben und Ausführungen für die genannten Materialien

5 **Additional information**

-

Aanvullende informatie

-

Weitere Informationen

-

6 **Cable management**



CM15
EVoline® One spot
Ø 5,9 cm

product

Essenza

designer

**Willem
van Ast**

year

1999 - 2018



Essenza is a solid wooden table with a pure and elegant design. Suitable as dining table but also as working table by applying refined cable management options.

Essenza is een massieve tafel met een pure vorm en elegante stijl. Geschikt als eettafel, maar ook als werktafel door de handige cable management opties.

Essenza ist ein massiver Tisch mit einer klaren Form und einem eleganten Stil. Geeignet als Esstisch aber auch als Arbeitstisch durch die ansprechende Cable Management Optionen.



1 **Essenza****Willem
van Ast**

1999 - 2018

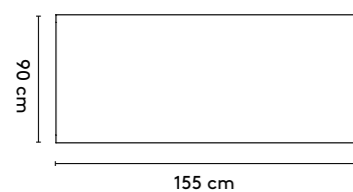
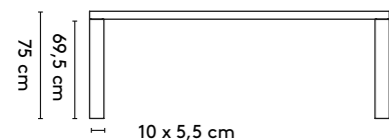
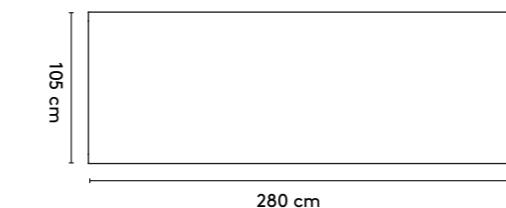
2a **Standard**Essenza rectangular 1Essenza rectangular XL

155 x 90 x 75 cm 210 x 105 x 75 cm
 190 x 90 x 75 cm 240 x 105 x 75 cm
 210 x 90 x 75 cm
 240 x 90 x 75 cm
 280 x 90 x 75 cm

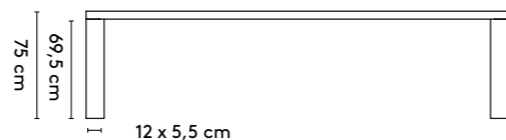

280 x 105 x 75 cm
 320 x 105 x 75 cm
 360 x 105 x 75 cm

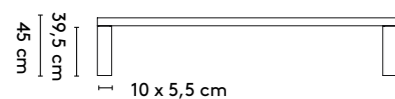
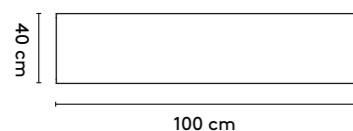
Essenza bench

100 x 40 x 45 cm
 150 x 40 x 45 cm
 180 x 40 x 45 cm
 220 x 40 x 45 cm

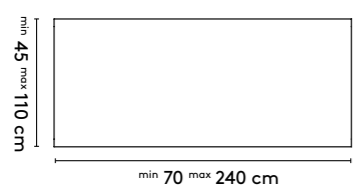
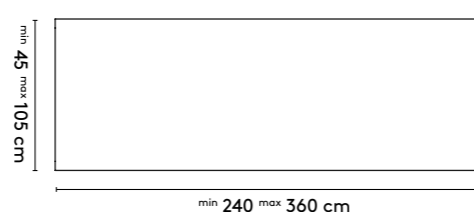
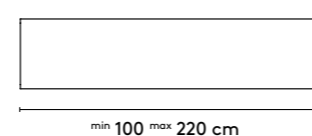
2b **Tailoring**Essenza rectangular 1Essenza rectangular XLEssenza bench3 **Materials**

Top: oak or walnut (solid), oak smoked (solid)
Legs: oak or walnut (solid), oak smoked (solid)

Materialen

Blad: eiken of noten (massief), eiken gerookt (massief)
 Poten: eiken of noten (massief, eiken gerookt (massief)

Materialien

Platte: Eiche oder Nussbaum (Massiv), Eiche geräuchert (Massiv)
 Beine: Eiche oder Nussbaum (Massiv), Eiche geräuchert (Massiv)

1 **Essenza****Willem
van Ast**

1999 - 2018

4 **Finishes**

All Arco colors and finishes for the mentioned materials

Afwerkingen

Alle Arco kleuren en (lak)afwerkingen voor de genoemde materialen

Ausführungen

Alle Arco Farben und Ausführungen für die genannten Materialien

5 **Additional information**

-

Aanvullende informatie

-

Weitere Informationen

-

6 **Cable management**

CM04
solid wood
30 x 15 cm

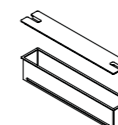

CM06/CM07
epoxy
30/50 cm



CM15
EVOLine® One spot
Ø 5,9 cm



CM08/CM09
cable-net
small/large



CM12
cable sock
large



CM13/CM14
zipper sock
short/long

product

Grid

designer

**Jonathan
Prestwich**

year

2014 - 2016



product

Grid

designer

**Jonathan
Prestwich**

year

2014 - 2016



The clever modular design of the Grid program allows for a wide variety of arrangements, be it for formal or informal meetings, landing or individual work. The Grid is ideal for dynamic work environments, such as offices or libraries.

Door het slimme modulaire ontwerp van het Grid programma kunnen verschillende opstellingen worden gerealiseerd, of het nu voor vergaderen, informeel overleggen, aanlanden of individueel werken is. De Grid is ideaal voor dynamische werkomgevingen zoals kantoren of bibliotheken.

Durch den modularen Entwurf des Grid-programm können verschiedene Einsatzmöglichkeiten realisiert werden, ob es nun um Konferenzen, informelle Gespräche, Kurzzeitarbeitsplätze oder individuelles Arbeiten geht. Der Grid ist perfekt für dynamische Arbeitsumgebungen wie Büros oder Bibliotheken geeignet.



product

1 Grid

designer

Jonathan Prestwich

year

2014 - 2016

2a Standard

Grid square

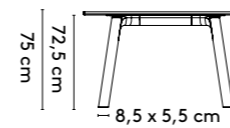
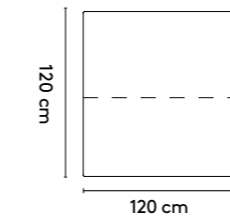

120 x 120 x 75 cm (between legs: 81 cm)
 150 x 150 x 75 cm (between legs: 81 cm)
 200 x 200 x 75 cm (between legs: 106 cm)

Grid round

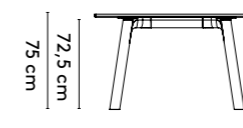
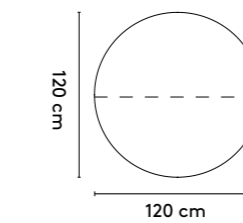

Ø 120 x 75 cm (between legs: 81cm)
 Ø 150 x 75 cm (between legs: 81cm)
 Ø 200 x 75 cm (between legs: 106cm)

Grid rectangular

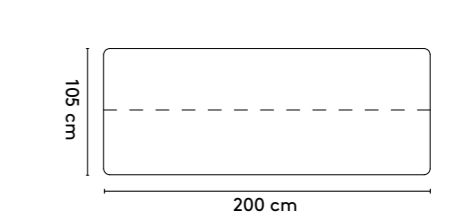

200 x 105/120/160 x 75 cm (between legs: 146cm)
 240 x 105/120/160 x 75 cm (between legs: 176cm)
 280 x 105/120/160 x 75 cm (between legs: 216cm)
 320 x 105/120/160 x 75 cm (between legs: 256cm)
 360 x 105/120/160 x 75 cm (between legs: 296cm)

Grid rectangular high

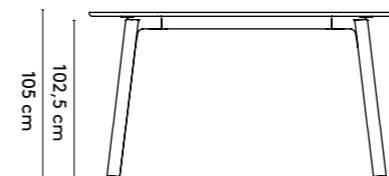
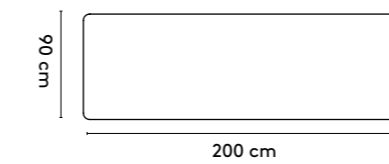

200 x 90 x 105 cm (between legs: 160 cm)
 240 x 90 x 105 cm (between legs: 200 cm)
 280 x 90 x 105 cm (between legs: 240 cm)

Grid rectangular connected

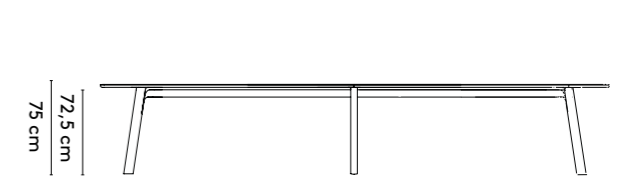
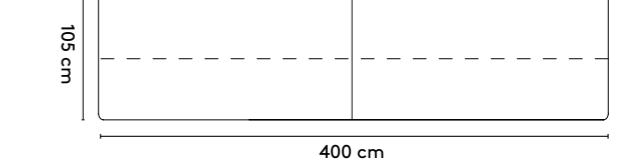

400 x 105/120 x 75 cm (between legs: 190 cm)
 480 x 105/120 x 75 cm (between legs: 230 cm)
 560 x 105/120 x 75 cm (between legs: 270 cm)

Grid barrel

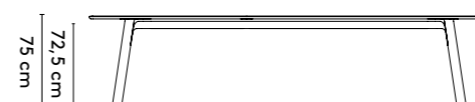
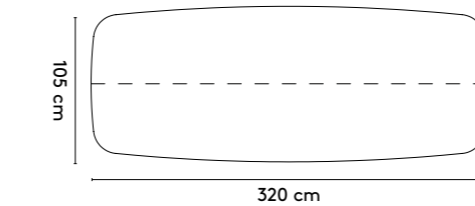

200 x 105/150 x 75 cm (between legs: 146 cm)
 240 x 105/150 x 75 cm (between legs: 178 cm)
 280 x 110/150 x 75 cm (between legs: 200 cm)
 320 x 110/150 x 75 cm (between legs: 240 cm)
 360 x 110/150 x 75 cm (between legs: 280 cm)

Grid barrel connected

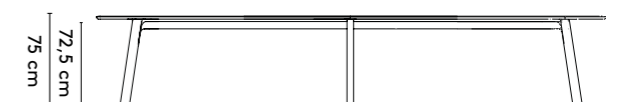
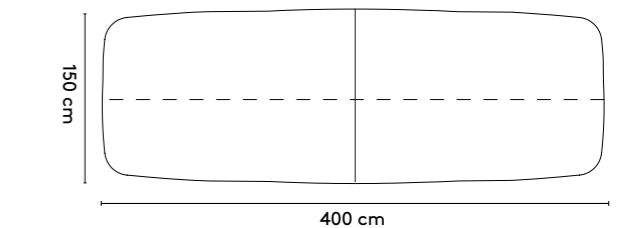

400 x 150 x 75 cm (between legs: 165 cm)
 480 x 150 x 75 cm (between legs: 197 cm)
 560 x 150 x 75 cm (between legs: 237 cm)

please note:
 a table top with a width/diameter wider than 128 cm comes in two parts.

1 product **Grid** designer **Jonathan Prestwich** year **2014 - 2016**

2b **Tailoring**

Grid square

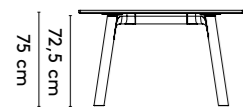
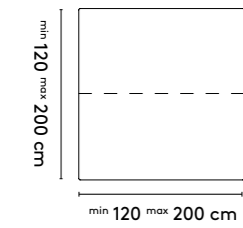

Grid round

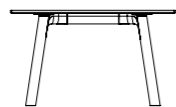
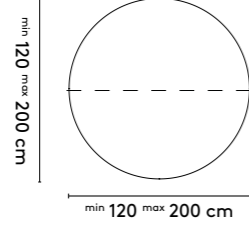

Grid rectangular

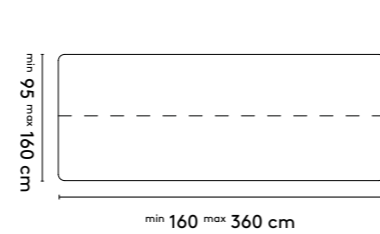

Grid rectangular high

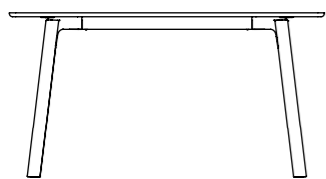
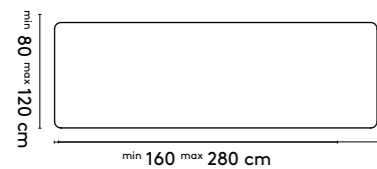

Grid rectangular connected

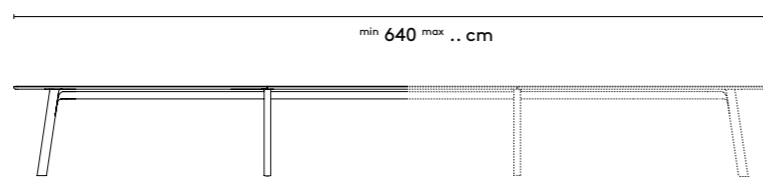
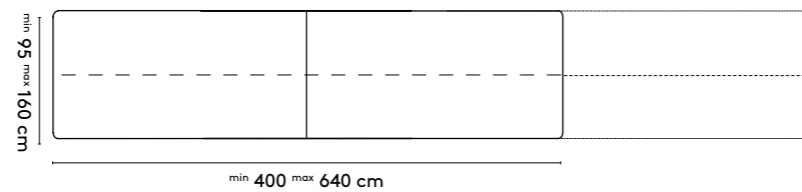

Grid barrel

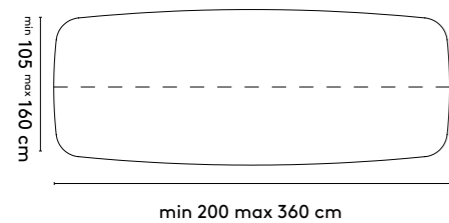

Grid barrel connected

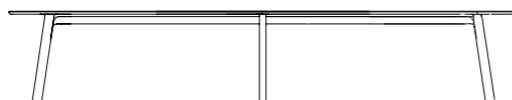
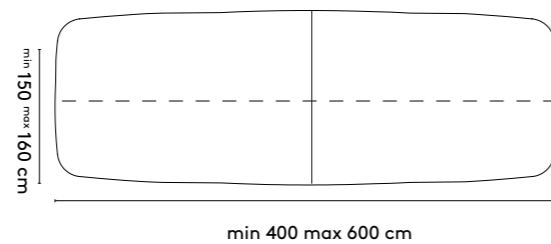

please note:
a table top with a width/diameter wider than 128 cm comes in two parts

3 **Materials**
Top: oak or walnut (solid, veneer), oak smoked (solid)
Frame: epoxy fine texture on aluminum (RAL9010 or RAL9005)
Legs: oak or walnut (solid)

Materialen
Blad: eiken of noten (massief, fineer), gerookt eiken (massief)
Onderstel: epoxy fine texture op aluminium (RAL9010 of RAL9005)
Poten: eiken of noten (massief)

Materialien
Platte: Eiche oder Nussbaum (Massiv, Furnier), Eiche geräuchert (Massiv)
Untergestell: Epoxy fine texture auf Aluminium (RAL9010 oder RAL9005)
Beine: Eiche oder Nussbaum (Massiv)

4 **Finishes**
All Arco colors and finishes for the mentioned materials

Afwerkingen
Alle Arco kleuren en (lak)afwerkingen voor de genoemde materialen

Ausführungen
Untergestell in einer anderen Farbe Epoxy fine texture (Arco Farbe) möglich

1 product **Grid** designer **Jonathan Prestwich** year **2014 - 2016**

5 **Additional information**

Aanvullende informatie

Weitere Informationen

6 **Cable management**



CM04 solid wood 30 x 15 cm

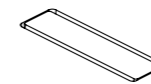

CM05 wood 30 x 10 cm



CM15 EVOLine® One spot Ø 5,9 cm

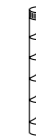

CM11 cable sock medium



CM13/CM14 zipper sock short/long

product

HAT

designer

**Jorre
van Ast**

year

2022



The office becoming a meeting space requires a flexible response. While "flexibility" is a broad concept, the height-adjustable table provides one practical answer. This table is designed to be used in multiple ways. It could be a meeting table, serve as a workplace or team table. As it doesn't look like a typical height adjustable table, it could even take the place of a dining table.

De werkomgeving als ontmoetingsplek vraagt om flexibiliteit; een breed concept waarop deze in hoogte verstelbare tafel één praktisch antwoord biedt. Deze tafel is ontworpen om gebruikt te worden op verschillende manieren, als vergadertafel, maar het is ook een even goede werktafel of teamtafel.

Die Arbeitsumgebung als Ort der Begegnung erfordert eine gewisse Flexibilität. „Flexibilität“ ist zwar ein weit gefasster Begriff, jedoch bietet der höhenverstellbare Tisch eine praktische Lösung. Der Tisch ist so konzipiert, dass er auf unterschiedliche Weise verwendet werden kann, als Besprechungstisch, Arbeitsplatz oder Teamtisch. Da er nicht wie ein typischer höhenverstellbarer Tisch aussieht, könnte er sogar als Esstisch verwendet werden.





product	designer	year
1 HAT	Jorre van Ast	2022
2 Standard		
<u>HAT rectangular 1</u>	<u>HAT rectangular 2</u>	
powered by cable	battery powered version, comes with charging cable	
180 x 90 cm 240 x 105 cm 210 x 90 cm 240 x 90 cm	180 x 90 cm 240 x 105 cm 210 x 90 cm 240 x 90 cm	
3 Materials	Materialen	Materialien
Top: oak (veneer, duramas) Legs: oak (veneer)	Blad: eiken (fineer, duramas) Onderstel: eiken (fineer)	Platte: Eiche (Furnier, Duramas) Füsse: Eiche (Furnier)
4 Finishes	Afwerkingen	Ausführungen
All Arco colors and finishes for the mentioned materials	Alle Arco kleuren en (lak)afwerkingen voor de genoemde materialen	Alle Arco Farben und Ausführungen für die genannten Materialien
5 Additional information	Aanvullende informatie	Weitere Informationen
-	-	-
6 Cable management		
CM15 EVOline® One spot Ø 5,9 cm	CM16 Avolt Square 1 7,6 x 7,6 x 7,6 cm	



product

Joist

designer

**Jorre
van Ast**

year

2019 - 2020

The central column provides lots of legroom and freedom of movement. The round shape makes Joist a table for socialising: everyone can see each other.

Door de centrale kolom is er veel beenruimte en bewegingsvrijheid. De ronde vorm maakt Joist een sociale tafel: iedereen kan elkaar aankijken.

Durch die zentrale Säule gibt es viel Bein- und Bewegungsfreiheit. Die runde Form macht den Joist zu einem sozialen Tisch: alle können einander ansehen.





product

designer

year

1 **Joist**

**Jorre
van Ast**

2019 - 2020

2a **Standard**

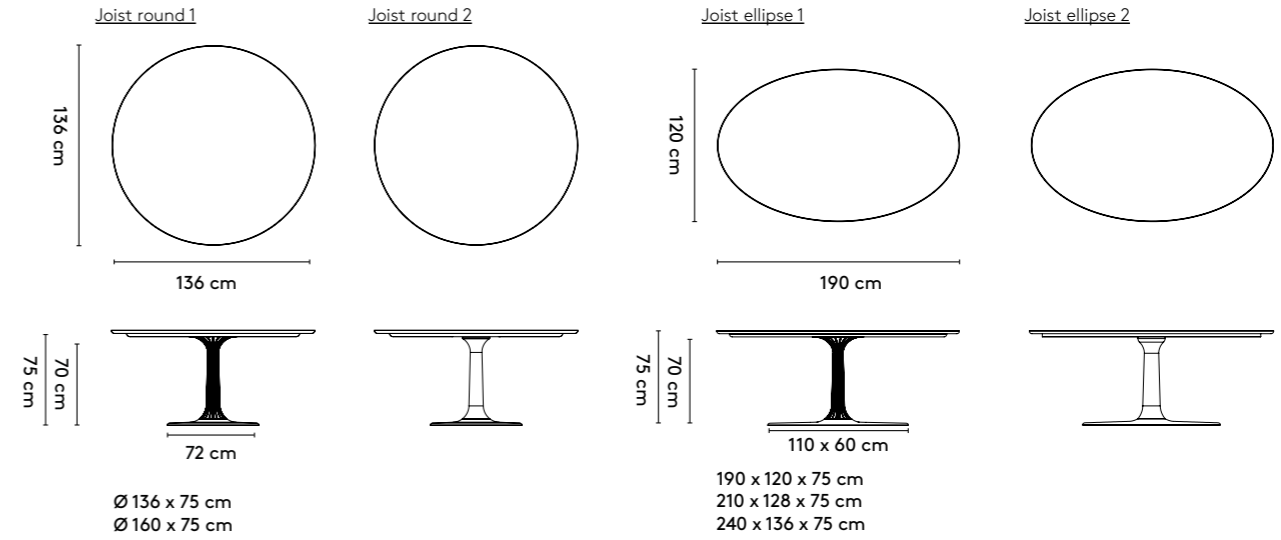

2b **Tailoring**

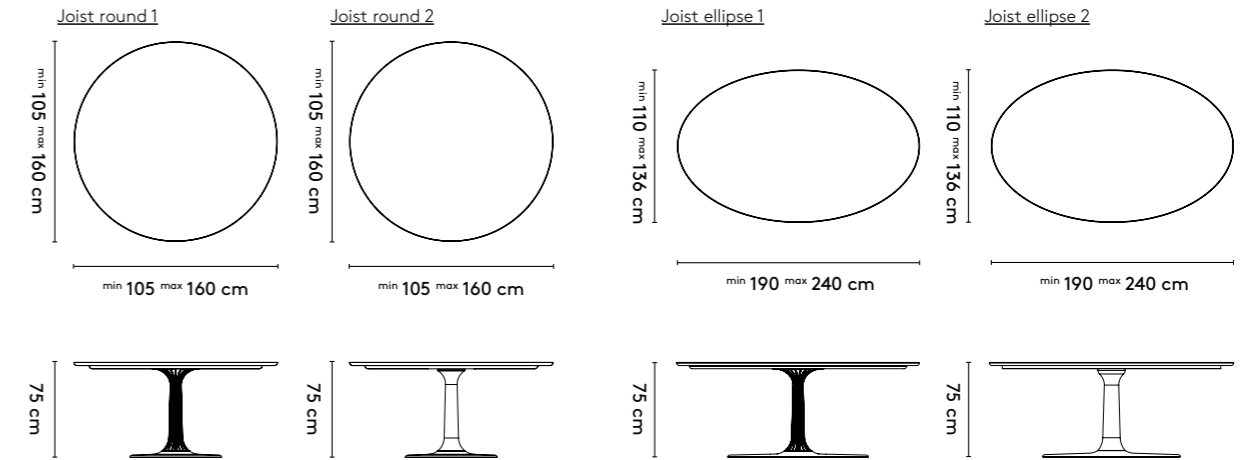

3 **Materials**

Top: oak or walnut (solid), oak smoked (solid)
Column: epoxy fine texture on aluminum (Joist 1), oak or walnut (solid), oak smoked (solid) (Joist 2)
Base: epoxy fine texture on aluminum

Materialen

Blad: eiken of noten (massief), gerookt eiken (massief)
Kolom: epoxy fine texture op aluminium (Joist 1), eiken of noten (massief), gerookt eiken (massief) (Joist 2)
Voet: epoxy fine texture op aluminium

Materialien

Platte: Eiche oder Nussbaum (Massiv), Eiche geräuchert (Massiv)
Säule: Epoxy fine texture auf Aluminium (Joist 1), Eiche oder Nussbaum (Massiv), Eiche geräuchert (Massiv) (Joist 2)
Fuss: epoxy fine texture auf Aluminium

4 **Finishes**

All Arco colors and finishes for the mentioned materials

Afwerkingen

Alle Arco kleuren en (lak)afwerkingen voor de genoemde materialen

Ausführungen

Alle Arco Farben und Ausführungen für die genannten Materialien

5 **Additional information**

-

Aanvullende informatie

-

Weitere Informationen

-

6 **Cable management**

-

product

Kami

designer

**Joost
van der Vecht**

year

2021



Kami is a wooden modular design table, built to be easily configured according to your wishes. You can adjust the Kami in almost endless ways: from a small intimate setting to an eye-catching version suitable for a boardroom. Kami collection has been developed in collaboration with Occony.

De Kami is een houten modulaire design tafel die is ontworpen om met gemak en naar wens te configureren, waarbij eindeloos in lengte geschakeld kan worden in verschillende uitvoeringen. Van een kleine intieme setting tot een grote blikvanger in een vergader- en boardroom omgeving. De Kami-collectie is in samenwerking met Occony ontwikkeld.

Der Kami ist ein modularer Holztisch, der entworfen wurde, um einfach und nach Ihren Wünschen konfiguriert zu werden. In den verschiedenen Ausführungen kann endlos in die Länge angebaut werden. Von einer kleinen intimen Umgebung zu einem großen Blickfang in einer Meeting- und Sitzungssaalumgebung. Die Kami-Kollektion wurde in Zusammenarbeit mit Occony entwickelt.





product

designer

year

1 **Kami**

Joost van der Vecht

2021

2a **Standard**

Kami Round

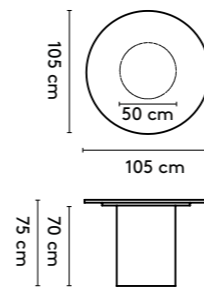

∅ 105 x 75 cm (1 column)
∅ 120 x 75 cm (1 column)

Kami Oval 1

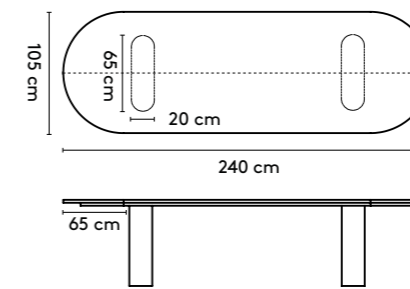

240 x 105/120/150 x 75 cm (2 columns)
280 x 105/120/150 x 75 cm (2 columns)
320 x 105/120/150 x 75 cm (2 columns)
360 x 105/120/150 x 75 cm (2 columns)

Kami Oval 2

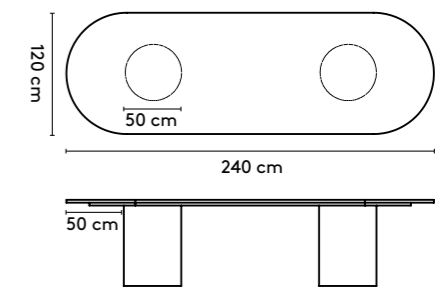

240 x 120 x 75 cm (2 columns)
280 x 120 x 75 cm (2 columns)
320 x 120 x 75 cm (2 columns)
360 x 120 x 75 cm (2 columns)

Kami Oval 1 connected

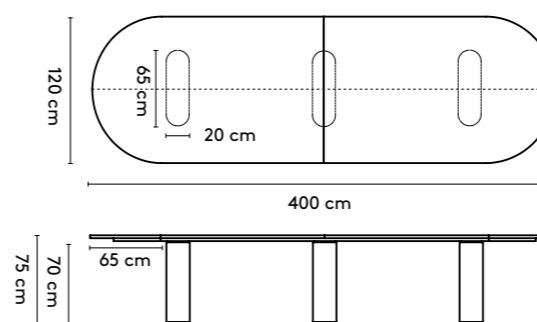

400 x 120/150 x 75 cm (3 columns) 560 x 120/150 x 75 cm (4 columns)
440 x 120/150 x 75 cm (3 columns) 600 x 120/150 x 75 cm (4 columns)
480 x 120/150 x 75 cm (3 columns) 640 x 120/150 x 75 cm (4 columns)
520 x 120/150 x 75 cm (4 columns) 680 x 120/150 x 75 cm (5 columns)
720 x 120/150 x 75 cm (5 columns)

Kami Oval 2 Connected

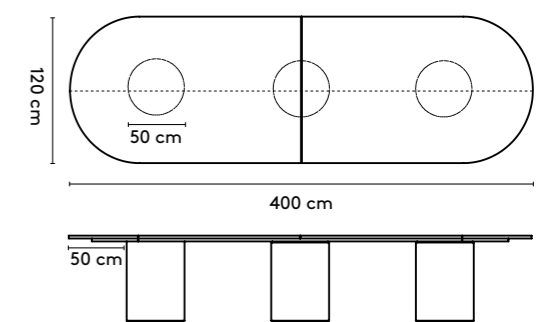

400 x 120 x 75 cm (3 columns) 560 x 120 x 75 cm (4 columns)
440 x 120 x 75 cm (3 columns) 600 x 120 x 75 cm (4 columns)
480 x 120 x 75 cm (3 columns) 640 x 120 x 75 cm (4 columns)
520 x 120 x 75 cm (4 columns) 680 x 120 x 75 cm (5 columns)
720 x 120 x 75 cm (5 columns)

please note:
a table top with a width wider than 128 cm and length longer than 360 comes in multiple parts

2b **Tailoring**

3 **Materials**

Top: oak or walnut (solid, veneer), oak smoked (solid)
Column: oak or walnut (veneer)

Materialen

Blad: eiken of noten (massief, fineer), eiken gerookt (massief)
Kolom: eiken of noten (fineer)

Materialien

Platte: Eiche oder Nussbaum (Massiv, Furnier), Eiche geräuchert (Massiv)
Säule: Eiche oder Nussbaum (Furnier)

4 **Finishes**

All Arco colors and finishes for the mentioned materials

Afwerkingen

Alle Arco kleuren en (lak)afwerkingen voor de genoemde materialen

Ausführungen

Alle Arco Farben und Ausführungen für die genannten Materialien

5 **Additional information**

Aanvullende informatie

Weitere Informationen

6 **Cable management**

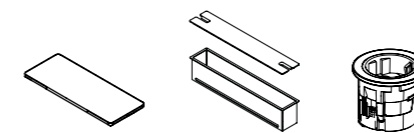

CM04
solid wood
30 x 15 cm

CM06/CM07
epoxy
30/50 cm

CM15
EVOLINE® One spot
Ø 5,9 cm

product

designer

year

Move

Hofman-
Dujardin

2022





These modular tables can be set up any way you wish in ever-changing configurations. Move is available as both a low and high table, optional with castors for easy configuration; turning individual work spaces into a table big enough for the whole team.

Deze modulaire tafels kunnen in steeds wisselende configuraties worden opgesteld. Verkrijgbaar als lage en hoge tafel optioneel met wielen om nog makkelijker te wisselen in opstelling. Van individuele werkplek naar een tafel die groot genoeg is voor het hele team.

Diese modularen Tische können Sie ganz nach Wunsch arrangieren. Erhältlich als niedriger und hoher Tisch, und mit Rollen für eine einfache Konfiguration. Von individueller Arbeitsplatz nach einen Tisch groß genug für das ganze Team.





product

designer

year

1 **Move**

**Hofman-
Dujardin**

2022

2 **Standard**

Move triangular 1

Move triangular 2

Move triangular high 1

Move triangular high 2

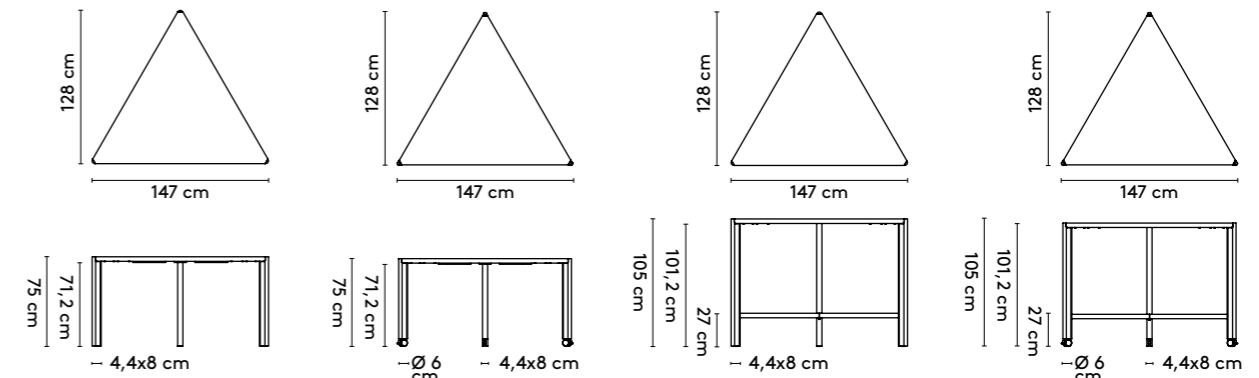

128 x 147 x 75 cm

128 x 147 x 105 cm

3 **Materials**

Top: oak or walnut (veneer, duramas),
Fenix® HPL, (black, white, grey)
Legs: oak or walnut (solid)
Footrest: epoxy fine texture on
aluminum

Materialen

Blad: eiken of noten (fineer, duramas),
Fenix® HPL (black, white, grey)
Onderstel: eiken of noten (massief)
Voetensteun: epoxy fine texture op
aluminium

Materialien

Platte: Eiche oder Nussbaum (Furnier, Duramas),
Fenix® HPL (black, white, grey)
Füsse: Eiche oder Nussbaum (Massiv)
Fußstütze: Epoxy fine texture auf Aluminium

4 **Finishes**

**All Arco colors and finishes for
the mentioned materials**

Afwerkingen

**Alle Arco kleuren en (lak)afwerkingen voor
de genoemde materialen**

Ausführungen

**Alle Arco Farben und Ausführungen für
die genannten Materialien**

5 **Additional information**

**The Move 2 is equipped with castors with
brakes and comes with invisible magnets
for easy configuration.**

Aanvullende informatie

**De Move 2 is voorzien van wielen met rem en
wordt geleverd met onzichtbare magneten
voor eenvoudige configuratie.**

Weitere Informationen

**Der Move 2 ist mit bremsbaren Rollen aus-
gestattet und wird mit unsichtbaren Magneten
für eine einfache Konfiguration geliefert.**

6 **Cable management**

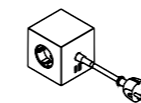

**CM16
Avolt Square 1
7,6 x 7,6 x 7,6 cm**

product

Shift

designer

**Jorre
van Ast**

year

2019





The Shift is a minimalist, slim (extendable) table with a friendly natural design. Form and function go together in the Shift: superb techniques are the special aspects in the extrusion profiles developed specifically for this table.

De Shift is een minimale, ranke (uitschuif)tafel met een vriendelijke, organische vormgeving. Voor de Shift geldt dat vorm en functie samengaan: alle techniek zit in de speciaal voor deze tafel ontwikkelde extrusie profielen.

Der Shift ist ein minimalistischer, schlanker Tisch mit einer ansprechenden, organischen Form. Für den Shift gilt, dass Form und Funktion kombiniert werden: die gesamte Technik befindet sich in den extra entwickelten Profilen des Tisches.

product

designer

year

1 **Shift**

Jorre van Ast

2019

2a **Standard**

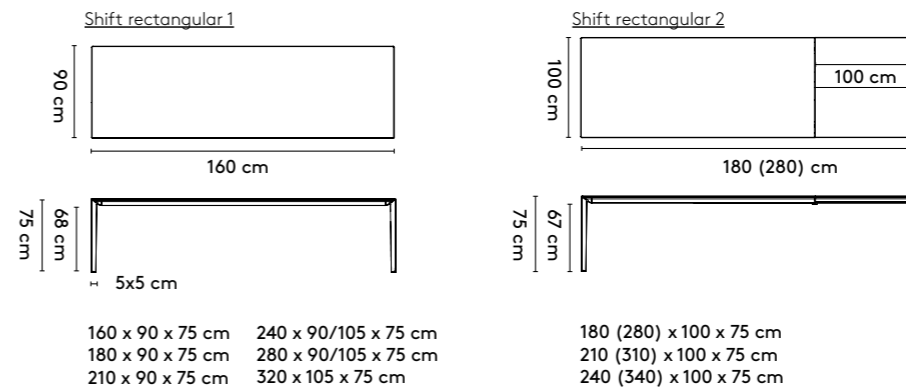

2b **Tailoring**

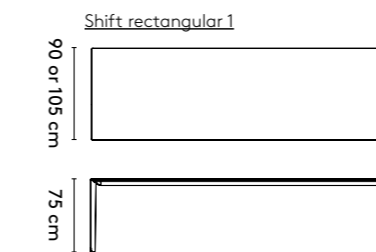

3 **Materials**

Top: oak or walnut (duramas), oak smoked (duramas)
Extension leaf: oak or walnut (duramas), oak smoked (duramas)
Base: epoxy fine texture on aluminum

Materialen

Blad: eiken of noten (duramas), gerookt eiken (duramas)
 Uitschuifblad: eiken of noten (duramas), gerookt eiken (duramas)
 Onderstel: epoxy fine texture op aluminium

Materialien

Platte: Eiche oder Nussbaum (Duramas), Eiche geräuchert (Duramas)
 Einlegeplatte: Eiche oder Nussbaum (Duramas), Eiche geräuchert (Duramas)
 Untergestell: Epoxy fine texture auf Aluminium

4 **Finishes**

All Arco colors and finishes for the mentioned materials

Afwerkingen

Alle Arco kleuren en (lak)afwerkingen voor de genoemde materialen

Ausführungen

Alle Arco Farben und Ausführungen für die genannten Materialien

5 **Additional information**

-

Aanvullende informatie

-

Weitere Informationen

-

6 **Cable management**

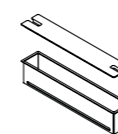

CM06/CM07 epoxy 30/50 cm



CM15 EVOline® One spot Ø 5,9 cm



CM08/CM09 cable-net small/large

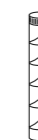

CM12 cable sock large



CM13 zipper sock short

product

Slim

designer

**Bertjan
Pot**

year

2005 - 2022





color lacquer on ash veneer Mustard



This ultra-thin, but nevertheless very stable table is made possible by a unique steel-sandwich construction, which is covered with a thin layer of wood.

Deze dunne, maar tegelijkertijd zeer stabiele tafel is mogelijk door een unieke staal-sandwich constructie, die voorzien is van een laagje hout.

Dieser dünne, aber gleichzeitig sehr stabile Tisch ist möglich durch eine einzigartige Stahl-Sandwich Konstruktion, die mit einer Holzschicht ummantelt wird.

product **Slim** designer **Bertjan Pot** year **2005 - 2022**

2a **Standard**

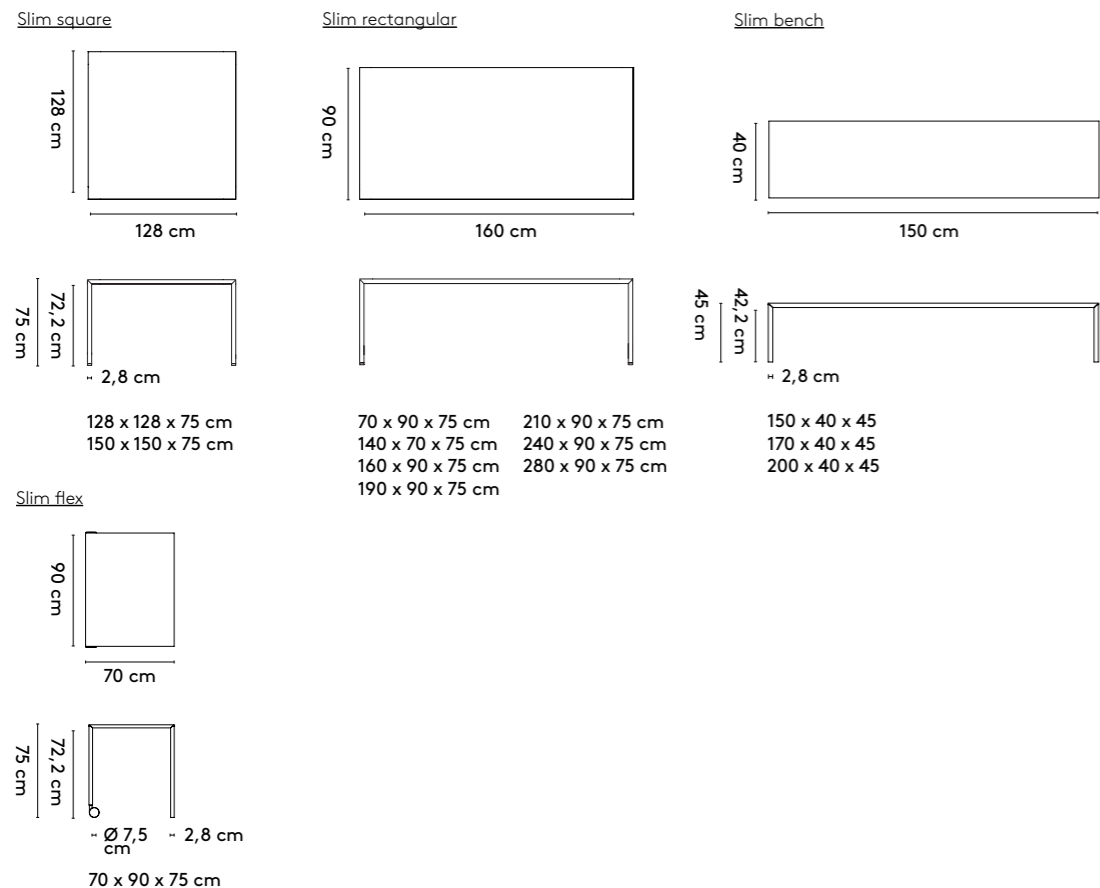

2b **Tailoring**

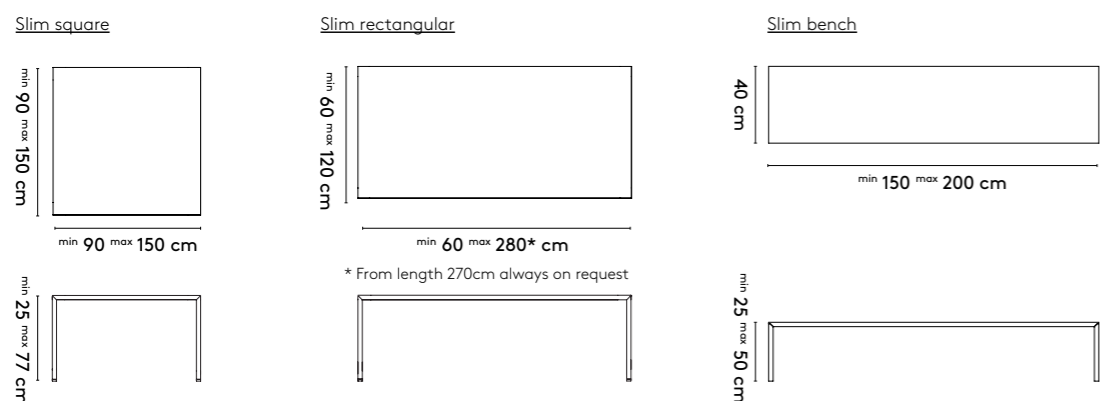

3 **Materials**

Top: oak or walnut (veneer, duramas), oak smoked (duramas), color lacquer on ash (veneer), Fenix® HPL, (black, white, grey)
Legs: oak or walnut (veneer), oak smoked (veneer), color lacquer on ash (veneer)

Materialen

Blad: eiken of noten (fineer, duramas), eiken gerookt (duramas), kleurlak op essen (fineer), Fenix® HPL (black, white, grey)
 Onderstel: eiken of noten (fineer), eiken gerookt (fineer), kleurlak op essen (fineer)

Materialien

Platte: Eiche oder Nussbaum (Furnier, Duramas), Eiche geräuchert (Duramas), Farblack auf Esche (Furnier), Fenix® HPL (black, white, grey)
 Füsse: Eiche oder Nussbaum (Furnier), Eiche geräuchert (Furnier), Farblack auf Esche (Furnier)

4 **Finishes**

All Arco colors and finishes for the mentioned materials

Afwerkingen

Alle Arco kleuren en (lak)afwerkingen voor de genoemde materialen

Ausführungen

Alle Arco Farben und Ausführungen für die genannten Materialien

product **Slim** designer **Bertjan Pot** year **2005 - 2022**

5 **Additional information**

Aanvullende informatie

Weitere Informationen

6 **Cable management**

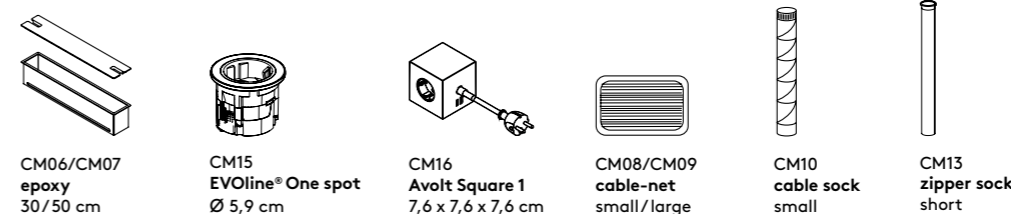

product

Slim+

designer

**Bertjan
Pot**

year

2011 - 2022



Slim+ is the larger version of the ultra-fine Slim Table introduced in 2005 and meets the for larger tables in general and a larger version of the successful Slim Table in particular. Slim+ has a maximum length of no less than 360 cm and is also available in a high table: Slim+ High.

De tafel Slim+ is de grotere versie van de in 2005 geïntroduceerde ragdunne Slim tafel. Hiermee komt Arco tegemoet aan de vraag naar grotere, lange tafels. De Slim+ tafel heeft een maximale lengte van maar liefst 360 cm en is ook als statafel verkrijgbaar: Slim+ High.

Slim+ ist die größere Version des im Jahr 2005 eingeführten schlanken Tisches Slim. Hiermit kommt Arco Wunsch nach größeren Tischen im Allgemeinen und nach dem erfolgreichen Tisch Slim im Besonderen nach. Slim+ hat eine maximale Länge von bis zu 360 cm. Es gibt auch eine Stehtisch-Version: Slim+ High.



product **Slim+** designer **Bertjan Pot** year **2011 - 2022**

2a **Standard**

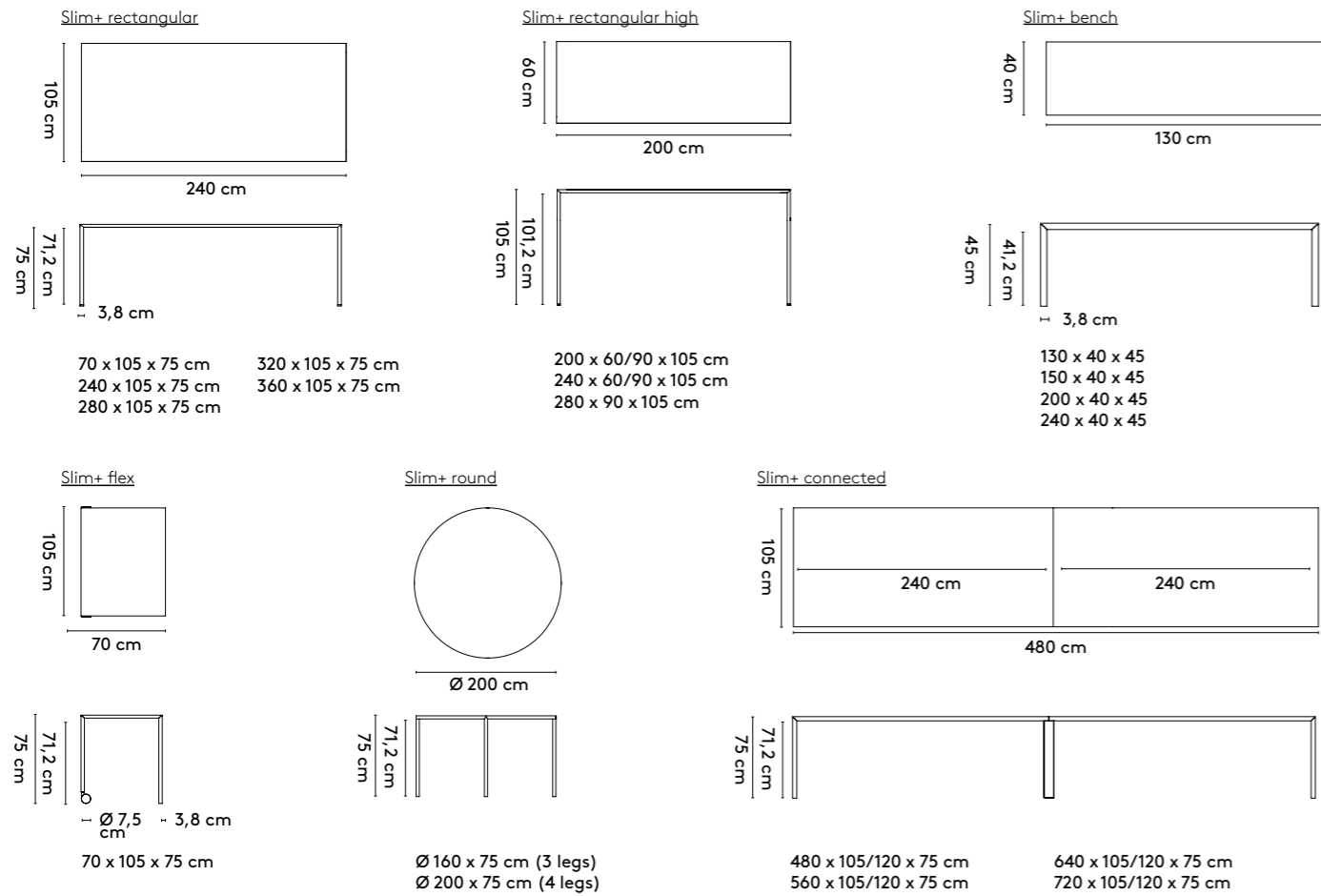

2b **Tailoring**

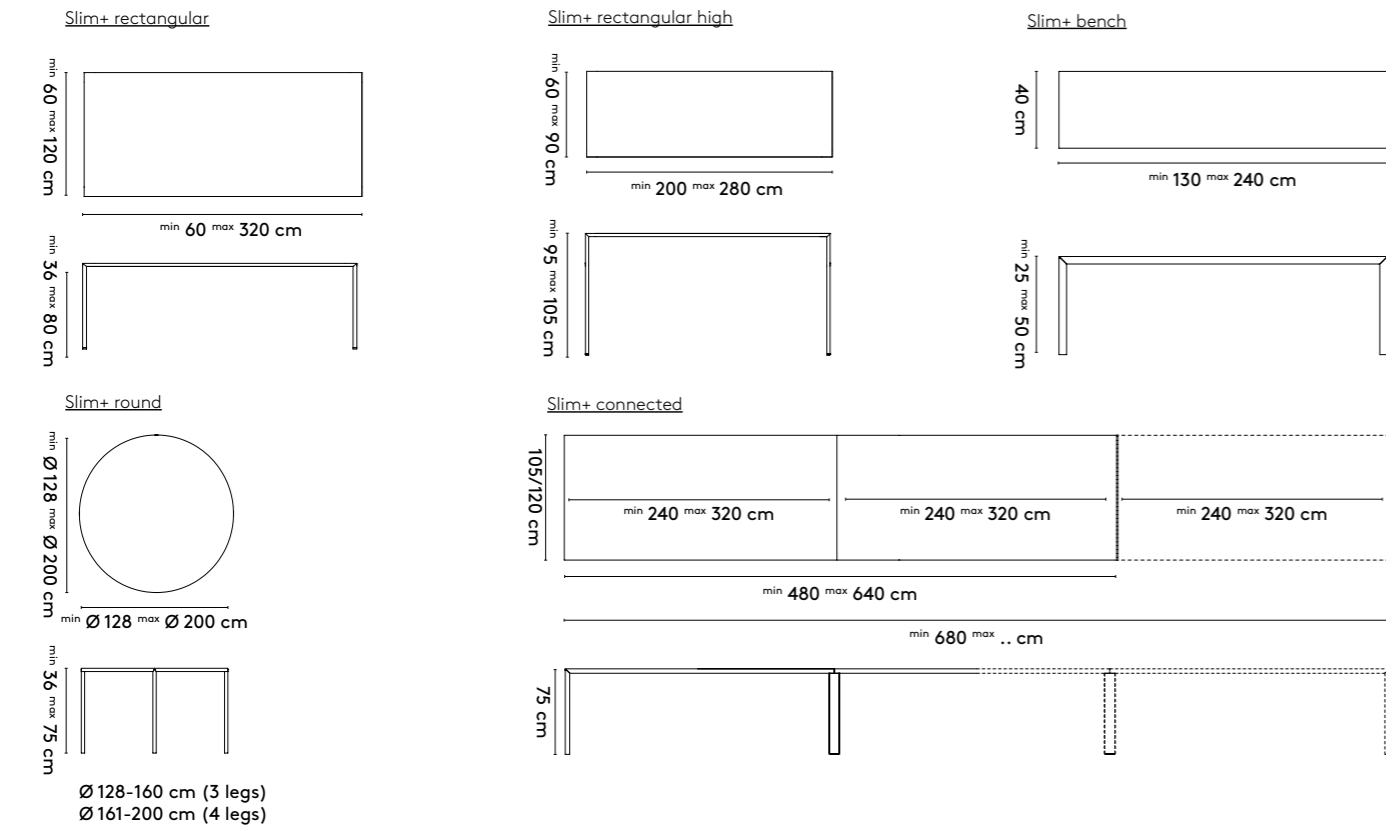

product **Slim+** designer **Bertjan Pot** year **2011 - 2022**

3 Materials Top: oak or walnut (veneer, duramas), oak smoked (duramas), color lacquer on ash (veneer), Fenix® HPL (black, white, grey) Legs: oak or walnut (veneer), oak smoked (veneer), color lacquer on ash (veneer)	Materialen Blad: eiken of noten (fineer, duramas), gerookt eiken (duramas), kleurlak op essen (fineer), Fenix® HPL (black white, grey) Onderstel: eiken of noten (fineer), gerookt eiken (fineer), kleurlak op essen (fineer)	Materialien Platte: Eiche oder Nussbaum (Furnier, Duramas), Eiche geräuchert (Duramas), Farblack auf Esche (Furnier), Fenix® HPL (black, white, grey) Füße: Eiche oder Nussbaum (Furnier), Eiche geräuchert (Furnier), Farblack auf Esche (Furnier)
4 Finishes All Arco colors and finishes for the mentioned materials	Afwerkingen Alle Arco kleuren en (lak)afwerkingen voor de genoemde materialen	Ausführungen Alle Arco Farben und Ausführungen für die genannten Materialien
5 Additional information -	Aanvullende informatie -	Weitere Informationen -
6 Cable management		
CM06/CM07 epoxy 30/50 cm	CM15 EVOline® One spot Ø 5,9 cm	CM16 Avolt Square 1 7,6 x 7,6 x 7,6 cm
CM08/CM09 cable-net small/large	CM10 cable sock small	CM13/CM14 zipper sock short/long



The ellipse top gives this robust column-table a characteristic elegance. The extension leaf of the extendable table is stored in the column and rises through a gas pressure system.

Het ellipsvormige blad geeft deze robuuste kolomtafel een heel eigen elegantie. Het inlegblad van de uitschuifbare Spazio tafel wordt in de kolom opgeborgen en komt via een gasdrukstelsysteem omhoog.

Die ellipsförmige Tischplatte gibt diesem stabilen Säulentisch eine sehr eigene Eleganz. Die Einlegeplatte des ausziehbaren Tisches ist in der Mittelsäule gelagert und wird mittels eines Gasdrucksystems nach oben befördert.

product

designer

year

1 **Spazio**

Willem van Ast

2007

2a **Standard**

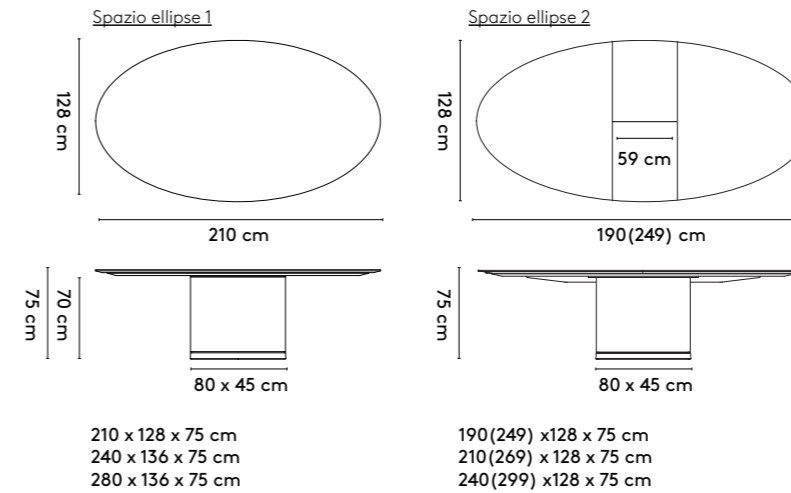

2b **Tailoring**

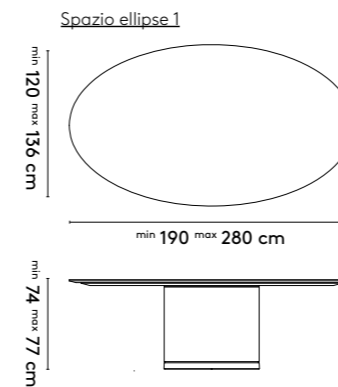

3 **Materials**

Top: oak or walnut (solid), oak smoked (solid), oak (veneer)
Extension leaf: oak or walnut (duramas), oak (veneer)
Column: oak or walnut (veneer), color lacquer on mdf
Base: color lacquer on concrete

Materialen

Blad: eiken of noten (massief), gerookt eiken (massief), eiken (fineer)
Uitschuifblad: eiken of noten (duramas), eiken (fineer)
Kolom: eiken of noten (fineer), kleurlak op mdf
Voet: kleurlak op beton

Materialien

Platte: Eiche oder Nussbaum (Massiv), Eiche geräuchert (Massiv), Eiche (Furnier)
Einlegeplatte: Eiche oder Nussbaum (Duramas), Eiche (Furnier)
Säule: Eiche oder Nussbaum (Furnier), Farblack auf mdf
Füß: Farblack auf Beton

4 **Finishes**

All Arco colors and finishes for the mentioned materials

Afwerkingen

Alle Arco kleuren en (lak)afwerkingen voor de genoemde materialen

Ausführungen

Alle Arco Farben und Ausführungen für die genannten Materialien

5 **Additional information**

-

Aanvullende informatie

-

Weitere Informationen

-

6 **Cable management**

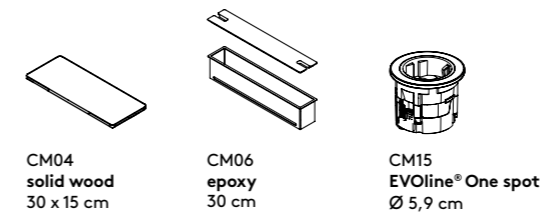



Jorre van Ast recasts the functional look of the trestle to create a generously proportioned table that will complement any living space. The three-legged aluminium trestle can be adjusted in height from 71 to 78 cm. The versatile Trestle Table comes in four sizes and looks good in a wide range of living spaces.

Jorre van Ast vertaalt met de Trestle Table de praktische uitstraling van een schragentafel uit de werkplaats naar een krachtige tafel om aan te leven. De Trestle Table is in hoogte verstelbaar door middel van draadspindels. De breed inzetbare tafel is leverbaar in vier maten en komt goed tot haar recht in diverse woonruimtes.

Mit dem großzügigen Trestle Table hat Jorre van Ast die funktionale Ausstrahlung eines Bocktischs auf ein Möbel für alle Lebensbereiche übertragen. Die Platte ruht auf jeweils dreibeinigen Aluminiumböcken, die manuell höhenverstellbar (71 bis 78 cm) sind. Der vielseitige Trestle Table kommt in den unterschiedlichsten Wohnräumen hervorragend zur Geltung.



1 **Trestle**Jorre
van Ast

2017 - 2018

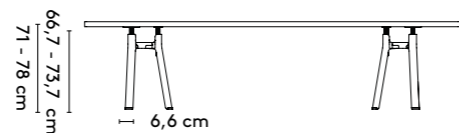
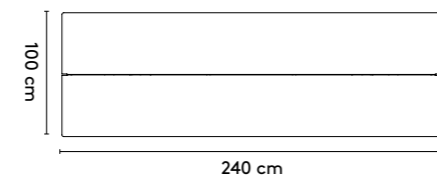
2a **Standard**Trestle rectangular 1 (thickened)Trestle rectangular 2 (solid)

240 x 100 x 71-78 cm (between legs: 178 cm)
 280 x 100 x 71-78 cm (between legs: 218 cm)
 320 x 105 x 71-78 cm (between legs: 258 cm)
 360 x 105 x 71-78 cm* (between legs: 258 cm)

240 x 100 x 71-78 cm (between legs: 178/158/138 cm)
 280 x 100 x 71-78 cm (between legs: 218/198/178 cm)
 320 x 105 x 71-78 cm (between legs: 258/238/218 cm)
 360 x 105 x 71-78 cm* (between legs: 258 cm)

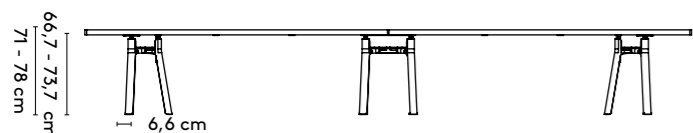
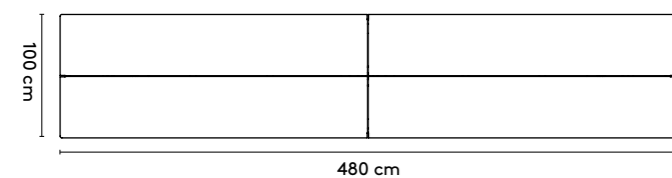
Trestle rectangular 2 connected

480 x 100 x 71-78 cm (between legs: 178/158/138 cm)
 560 x 100 x 71-78 cm (between legs: 218/198/178 cm)

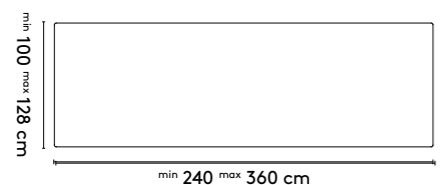
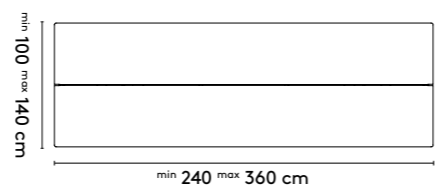
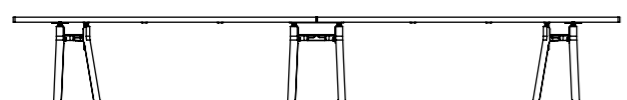
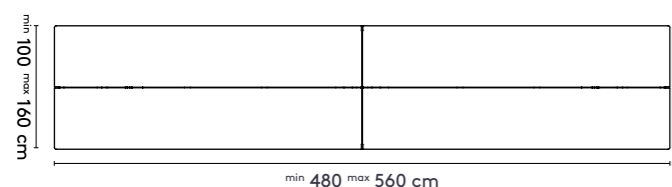
2b **Tailoring**Trestle rectangular 1Trestle rectangular 2Trestle rectangular 2 connected**Trestle**Jorre
van Ast

2017 - 2018

3 **Materials**

Top: oak (solid, local wood) or walnut (solid), oak smoked (solid)
Legs: epoxy fine texture on aluminum

Materialen

Blad: eiken (massief, lokaal hout) of noten (massief), eiken gerookt (massief)
 Onderstel: epoxy fine texture op aluminium

Materialien

Platte: Eiche (Massiv, lokales Holz) oder Nussbaum (Massiv), Eiche geräuchert (Massiv)
 Untergestell: Epoxy fine texture auf Aluminium

4 **Finishes**

All Arco colors and finishes for the mentioned materials

Afwerkingen

Alle Arco kleuren en (lak)afwerkingen voor de genoemde materialen

Ausführungen

Alle Arco Farben und Ausführungen für die genannten Materialien

5 **Additional information**

Legs can be mounted at 30, 40 or 50 cm from the short side of the table.
 Legs can be mounted at 50 cm only for size 360 cm

Aanvullende informatie

Onderstel kan worden gemonteerd op 30, 40, 50 cm van de korte zijde van de tafel
 Onderstel kan bij 360 cm alleen op 50 cm worden gemonteerd

Weitere Informationen

Untergestell kann auf 30, 40 und 50 cm der kurze Seite des Tisches montiert werden
 Untergestell kann bei 360 cm nur auf 50 cm montiert werden

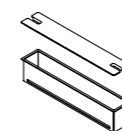
6 **Cable management**

CM06/CM07
epoxy
30/50 cm



CM15
EVoline® One spot
Ø 5,9 cm



CM08/CM09
cable-net
small/large



CM11
cable sock
medium



CM13
zipper sock
short



we are connected

Kuipersweg, Winterswijk
N51.91.129, E 7.74.782

product

1 Cable Management Overview

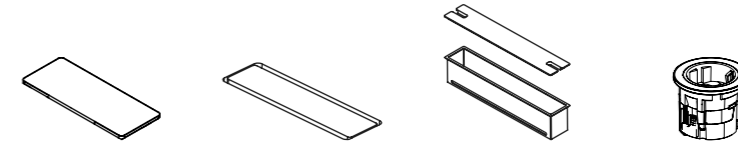

Table	CM04	CM05	CM06/07	CM15
Balance				
Base			X	X
Cast			X	X
Dew				X
Essential				X
Essenza	X		X	X
Grid	X	X		X
HAT				X
Joist				
Kami	X		X	X
Move				
Shift			X	X
Slim			X	X
Slim+			X	X
Spazio	X		X	X
Trestle			X	X

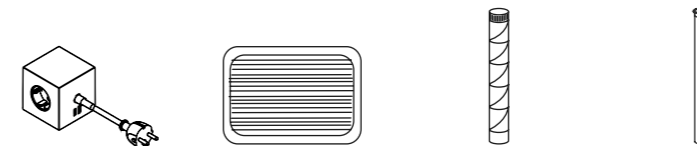
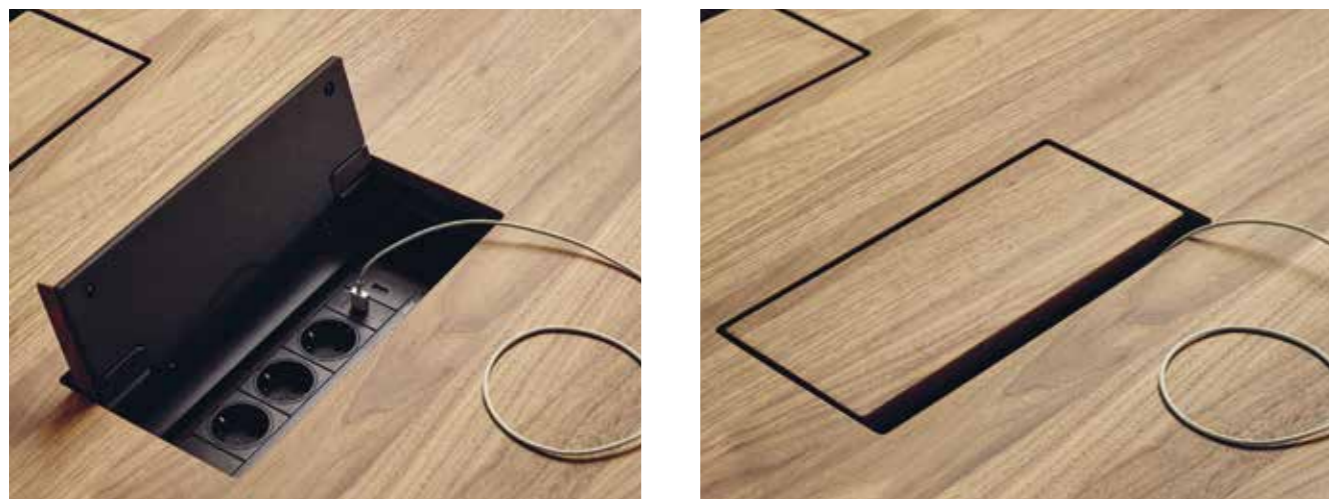

Table	CM16	CM08/09	CM10/11/12	CM13/14
Balance				
Base		X	CM12	X
Cast		X	CM12	X
Dew		X		
Essential		X		
Essenza		X	CM12	X
Grid			CM11	X
HAT	X			
Joist				
Kami		X		
Move	X			
Shift		X	CM12	X
Slim	X	X	CM10	X
Slim+	X	X	CM10	X
Spazio				
Trestle		X	CM11	X

1 CM04



1 CM04

2 Standard

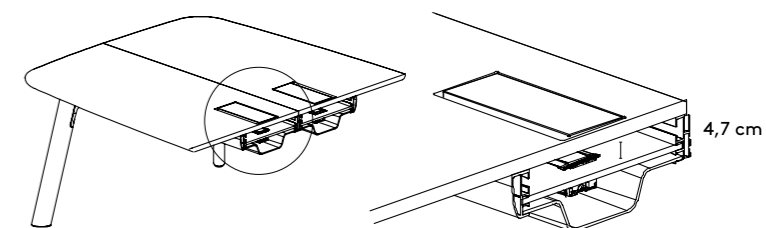

3 Materials

Cable lid
oak or walnut (solid)

Materialen

Kabel klep
eiken of noten (massief)

Materialien

Kabel Deckung
Eiche oder Nussbaum (massiv)

4 Finishes

All Arco colors and finishes for the
mentioned materials

Afwerkingen

Alle Arco kleuren en (lak)afwerkingen voor de
genoemde materialen

Ausführungen

Alle Arco Farben und Ausführungen für die
genannten Materialien

5 Additional information

Standard with EVOLINE® FrameDock 2 or 3
modules

Aanvullende informatie

Standaard met EVOLINE® FrameDock 2 of 3
modules

Weitere Informationen

Standard mit EVOLINE® FrameDock 2 oder 3
Module

6 Cable management



CM10/CM11/CM12
cable sock
medium



CM13
zipper sock

7 Electrification

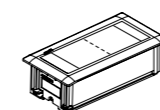

EVOLINE®
FrameDock
2 - 3 modules



Socket
module



RJ45
module



HDMI
module



USB
charger
module

1 CM05

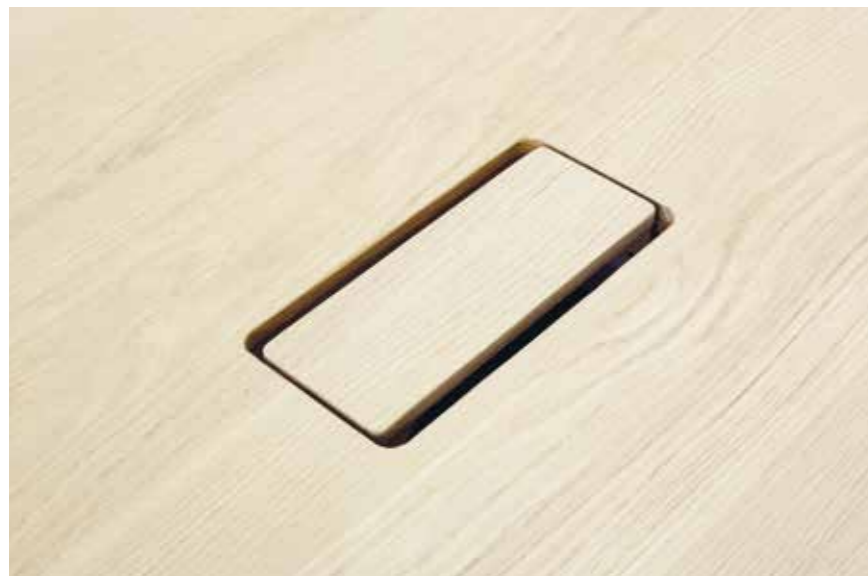

1 CM05

2 Standard

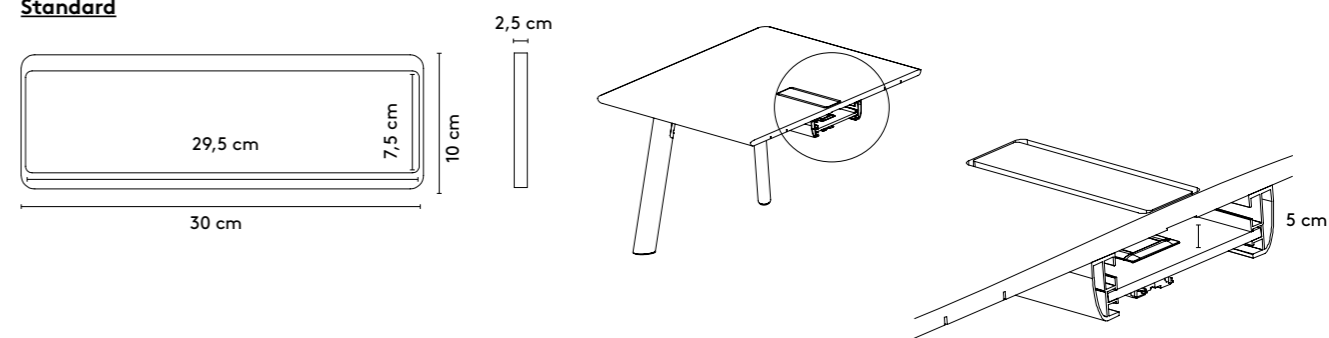

3 Materials

Cable lid
oak or walnut (solid, veneer)

Materialen

Kabel klep
eiken of noten (massief, fineer)

Materialien

Kabel Deckung
Eiche oder Nussbaum (massiv, furnier)

4 Finishes

All Arco colors and finishes for the mentioned materials

Afwerkingen

Alle Arco kleuren en (lak)afwerkingen voor de genoemde materialen

Ausführungen

Alle Arco Farben und Ausführungen für die genannten Materialien

5 Additional information

Standard with EVoline® FrameDock 2 or 3 modules

Aanvullende informatie

Standaard met EVoline® FrameDock 2 of 3 modules

Weitere Informationen

Standard mit EVOLINE® FrameDock 2 oder 3 Module

6 Cable management

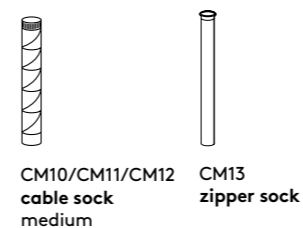

7 Electrification

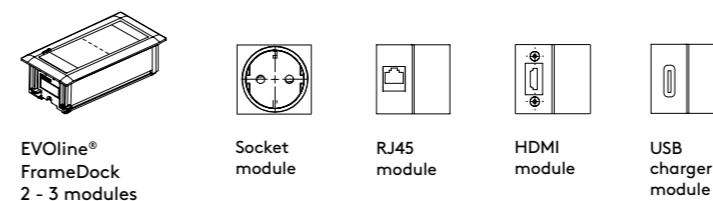

1 **CM06 (small)/
CM07 (large)**



1 **CM06 (small)/
CM07 (large)**

2 **Standard**

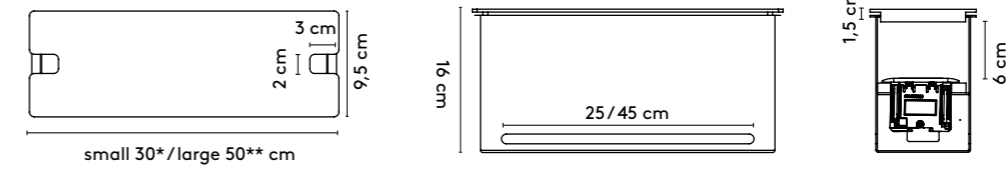

3 **Materials**

Cable lid
oak (solid)

Cable box
epoxy fine texture (RAL9005, RAL9010)

Inlay cable box
oak (veneer)

Materialen

Kabel klep
eiken (massief)

Kabel box
epoxy fine texture (RAL9005, RAL9010)

Inlay kabel box
eiken (fineer)

Materialien

Kabel Deckung
Eiche (massiv)

Kabel Box
Epoxy fine texture (RAL9005, RAL9010)

Inlay Kabel Box
Eiche (furnier)

4 **Finishes**

All Arco colors and finishes for the mentioned materials

Afwerkingen

Alle Arco kleuren en (lak)afwerkingen voor de genoemde materialen

Ausführungen

Alle Arco Farben und Ausführungen für die genannten Materialien

5 **Additional information**

Standard with EVOline® FrameDock
* Up to 3 modules
** Up to 7 modules

Aanvullende informatie

Standaard met EVOline® FrameDock
* Maximaal 3 modules
** Maximaal 7 modules

Weitere Informationen

Standard mit EVOline® FrameDock
* Maximum 3 Module
** Maximum 7 Module

6 **Cable management**

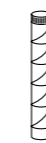

CM10/CM11/CM12
cable sock



CM13/CM14
zipper sock

7 **Electrification**

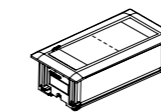

EVOline®
FrameDock
2 - 7 modules



Socket
module



RJ45
module



HDMI
module



USB
charger
module

1 **CM08/09**
CM10/11/12
CM13/14



The Cable sock conduct cables in an elegant and functional way from the table to the plug connection. The Cable net hides cables and adaptors underneath the table top.

De Cable sock begeleidt snoeren en kabels op een elegante manier van de tafel naar het stopcontact. Het Cable net verbergt snoeren en adapters onder het tafelblad.

Die Cable Sock führt Kabel und Leitungen in einem eleganten Weg aus den Tisch in die Steckdose. Das Cable Net verbirgt Kabel und Adapter unter dem Tisch.

1 **CM08/09**
CM10/11/12
CM13/14

2 **Standard**

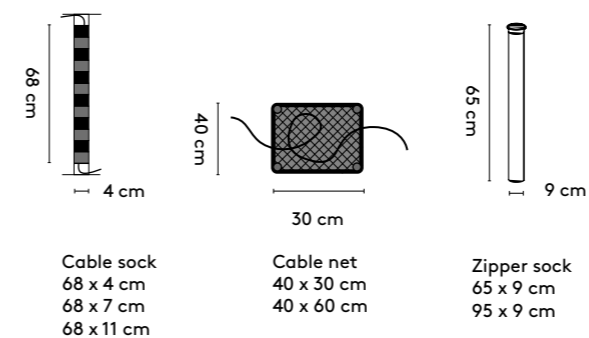

3 **Materials**

Cable sock
3d knitted fabric (black, green/blue, red/blue)

Cable net
Knitted fabric, synthetic (black)

Zipper sock
3d knitted fabric (black)

Materialen

Cable sock
3d gebreide stof (black, green/blue, red/blue)

Cable net
Gebreide stof, kunststof (black)

Zipper sock
3d gebreide stof (black)

Materialien

Cable sock
3d gestrickter Stoff (black, green/blue, red/blue)

Cable net
Gestrickter Stoff, Kunststoff (black)

Zipper sock
3d gestrickter Stoff (black)

4 **Finishes**

-

Afwerkingen

-

Ausführungen

-

5 **Additional information**

-

Aanvullende informatie

-

Weitere Informationen

-

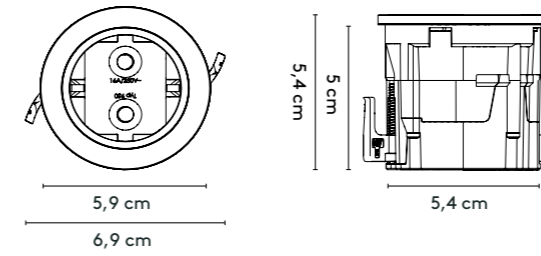
1 **CM15**1 **CM15**2 **Standard**3 **Materials**

-

Materialen

-

Materialien

-

4 **Finishes**

-

Afwerkingen

-

Ausführungen

-

5 **Additional information**
Version as EVoline® One Spot
Up to 4 spots per table top**Aanvullende informatie**
Uitgevoerd als EVoline® One Spot
Maximaal 4 spots per blad**Weitere Informationen**
Ausgeführt als EVoline® One Spot
Maximum 4 Spots pro Tischplatte6 **Cable management**CM10/CM11/CM12
cable sockCM13/CM14
zipper sock7 **Electrification**

Socket



RJ45



HDMI

USB
charger

CM16



Square 1 from Avolt. The Square with 1.8-meter cord, three sockets and two USB-A ports enable you to charge your devices convenient and fast. Attach your Square to our Slim table or under a desk with the integrated magnet and the included metal plate and 3M tape.

Square 1 van Avolt. Deze vierkante stekkerdoos met snoer van 1,8 meter heeft 3 stekker ingangen en 2 USB-A-poorten. De Square 1 heeft een magnetische bodem en kan daardoor aan de Slim tafel bevestigd worden, of met het bijgeleverde metalen plaatje en 3M-tape, onder je werkplek bevestigd worden.

Square 1 von Avolt. Diese würfelförmige Mehrfachsteckdose mit 1,8-Meter-Kabel bietet 3 Steckdosen und 2 USB-A-Anschlüsse. Square 1 verfügt über einen integrierten Magneten und lässt sich daher einfach an einem Slim Tisch anbringen oder mithilfe des mitgelieferten Eisenblechs mit 3M-Band unter deinem Arbeitsplatz befestigen.

CM16

2 Standard

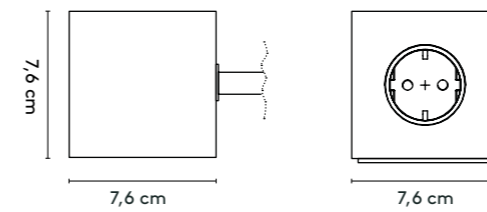

3 Materials

Enclosure
Zinc aluminum alloy and plastic
(PC, ABS) (20% recycled)

Materialen

Behuizing
Zink aluminiumlegering en plastic
(PC, ABS) (20% gerecycled)

Materialien

Gehege
Zink-Aluminium-Legierung und Kunststoff
(PC, ABS) (20 % recycelt)

4 Finishes

Colors
Stockholm Black

Afwerkingen

Kleuren
Stockholm Black

Ausführungen

Farben
Stockholm Black

5 Additional information

Version as Avolt Square 1

Aanvullende informatie

Uitgevoerd als Avolt Square 1

Weitere Informationen

Ausgeführt als Avolt Square 1

6 Cable management

-

Cable management

-

Cable management

-

7 Electrification

Plug & socket type : 3x Schuko Type F
USB type: 2x USB Type A

Electrification

Stekker & stopcontact type : 3x Schuko Type F
USB-type: 2x USB Type A

Electrification

Stecker- und Steckdosentyp: 3x Schuko Typ F
USB-Typ: 2x USB Typ A



EVERYTHING
WE KNOW
ABOUT TABLES,

APPLIED
TO
CHAIRS.





p. 170

Arc

Arc



p. 216

(Low tables & Flexible objects)

Bow

Bow



p. 76
(Tables)

Base Bench

Base Bench



p. 176

Close 1
Close 2
Close+ 2
Close Lounge
Close Barstool
Close Bench

Close 2



p. 172

Bock 1-seater
Bock 2-seater

Bock 2-seater



p. 182

Ease

Ease

we last generations

Steengroeveweg, Winterswijk
N 51.966488, E 6.787035



p. 94

(Tables)

Essenza Bench

Essenza with Essenza Bench



p. 192

Laze

Laze



p. 186

**Flux 1
Flux 2**

Flux 1



p. 196

Re-volve

Re-volve



p. 188

**Frame
Frame XL
Frame II
Frame II XL
Frame Bench**

Frame



p. 200

Side by Side

Side by Side



Wooldse Veen, Winterswijk
N 51.90.970, E 6.74.512



Slim with Slim Bench

p. 128

(Tables)

Slim Bench



Sketch Regular

p. 208

**Sketch
Regular**



Slim+ with Slim+ Bench

p. 134

(Tables)

Slim+ Bench



Sketch Work Middle

p. 204

Sketch Office



we produce local



From a technical perspective, the construction is a masterpiece: the shape is built of wooden 'ribs' which are in turn covered with a layer of wood (oak).

Constructie-technisch is deze bank een hoogstandje: de vorm wordt opgebouwd uit houten "ribben" die daarna worden voorzien van een laag eiken hout.

Die Bank ist aufwändig konstruiert: die Form wird in hölzernen "Rippen" aufgebaut, die danach mit einer Holzschicht (Eiche) bekleidet wird.

product

designer

year

1 **Arc**

**Bertjan
Pot**

2008

2 **Standard**

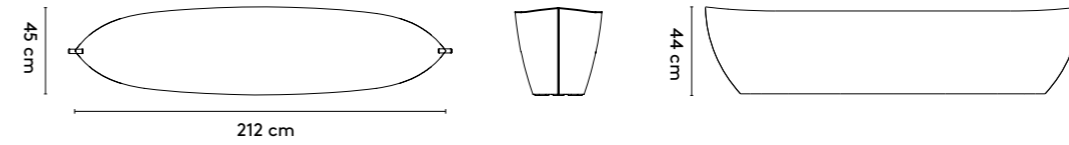

3 **Materials**

**Top: oak (solid)
Body: oak (veneer)
Straps: leather (natural, brown)**

Materialen

**Blad: eiken (massief)
Romp: eiken (fineer)
Grepes: leder (natural, brown)**

Materialien

**Platte: Eiche (Massiv)
Korpus: Eiche (Furnier)
Trageschlaufen: Leder (natural, brown)**

4 **Finishes**

All Arco colors and finishes for the mentioned materials

Afwerkingen

Alle Arco kleuren en (lak)afwerkingen voor de genoemde materialen

Ausführungen

Alle Arco Farben und Ausführungen für die genannten Materialien

5 **Additional information**

-

Aanvullende informatie

-

Weitere Informationen

-

product

Bock

designer

**Carolin
Zeyher**

year

2020



Thanks to its fusion of traditional and contemporary craftsmanship, the Bock is a new archetype when it comes to seating for work, living and hospitality. This versatile typology lends itself to environments where flexibility is desired.

Een nieuw archetype zit-object voor de werk, woon en hospitality omgeving. Het ontwerp stimuleert een gezonde en actieve zithouding en is een samensmelting van zowel traditioneel als hedendaags vakmanschap. Deze veelzijdige typologie leent zich voor omgevingen waar behoefte is aan flexibiliteit.

Bock steht für einen neuen Archetyp des Sitzens für Arbeits-, Wohn- und Gaststättenbereiche. Das Design regt zu einer gesunden und aktiven Sitzhaltung an und verbindet traditionelle und zeitgenössische Handwerkskunst. Dieser vielseitige Charakter bietet sich für Umgebungen an, in denen Flexibilität gewünscht ist.



product **1 Bock** designer **Carolyn Zeyher** year **2020**

2 **Standard**

Bock

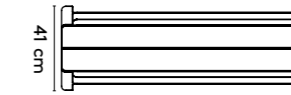
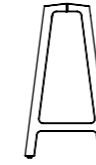
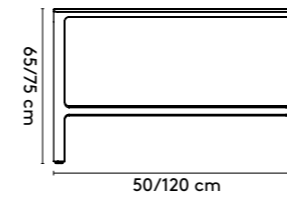

Tablet

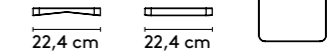

50x41x65/75 cm (1 zits)
120x41x65/75 cm (2 zits)

22,4x22,4 cm

3 **Materials**

Seat: oak (solid)
Footrest: black plastic foot strip

Materialen

Zitting: eiken (massief)
Voetensteun: zwarte kunststof strip

Materialien

Sitz: Eiche (Massiv)
Füsstütze: schwarzer kunststoff Streifen

4 **Finishes**

All Arco colors and finishes for the mentioned materials

Afwerkingen

Alle Arco kleuren en (lak)afwerkingen voor de genoemde materialen

Ausführungen

Alle Arco Farben und Ausführungen für die genannten Materialien

5 **Additional information**

-

Aanvullende informatie

-

Weitere Informationen

-

product

Close

designer

**Gudmundur
Ludvik**

year

2016-2022





The chairs from the Close family are as comfortable as they look: the round backrest provides a lot of seating comfort because it pleasantly shapes itself around you. De Close family exists of the Close, Close Plus, Close Bench, Close Lounge and Close Barstool: the elegance of this seating furniture flows from its beautiful simplicity.

Voor de stoelen uit de Close familie geldt dat ze net zo comfortabel zitten als dat ze er uit zien. De ronde rug zorgt voor veel zitcomfort doordat hij zich om je rug heen vormt. De Close familie bestaat uit de Close, Close Plus, Close Bench, Close Lounge en Close Barstool. De elegantie van deze serie zitmeubelen vloeit voort uit de eenvoud van het ontwerp.

Die Stühle aus der Close-Familie sind so bequem wie sie aussehen. Die runde Rückenlehne sorgt für viel Sitzkomfort, weil sie sich angenehm an den Rücken schmiegt. Die Close-Familie besteht aus Close, Close plus, Close Bench, Close Lounge und Close Barstool: eine elegante Sitz-möbelserie, die Schlichtheit ausstrahlt.

1 **Close****Gudmundur
Ludvik**

2016-2022

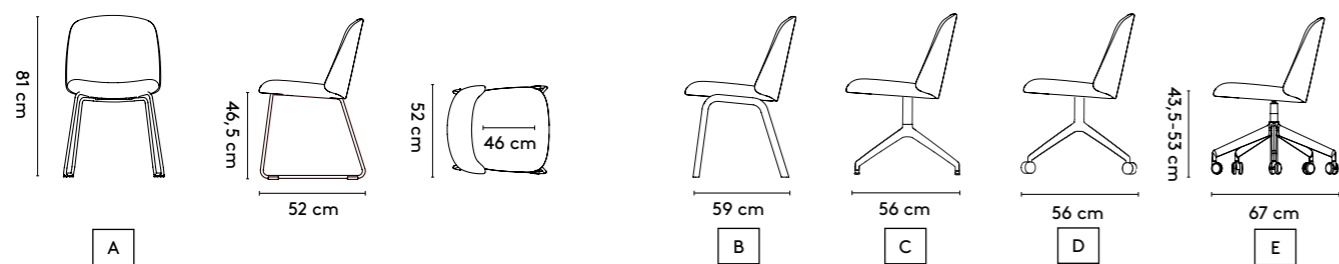
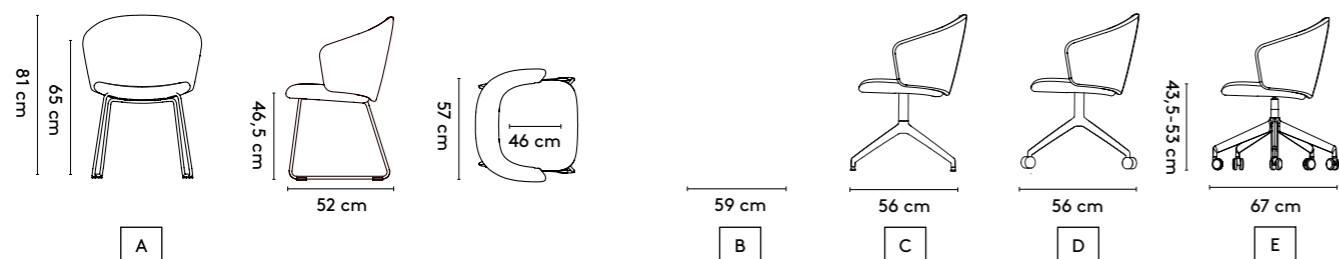
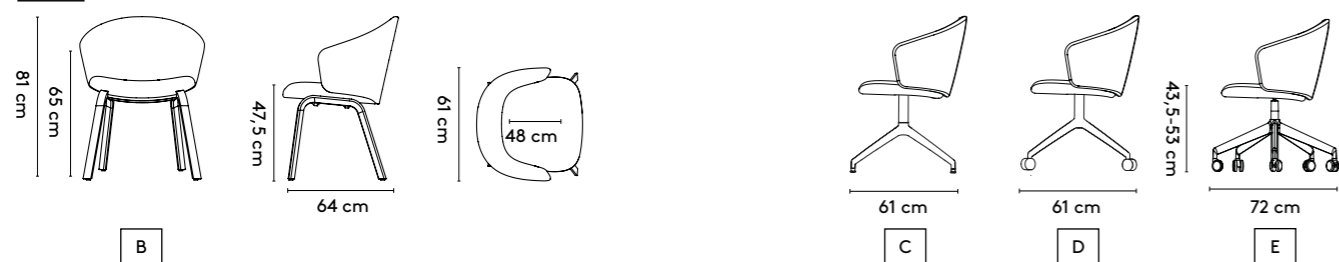
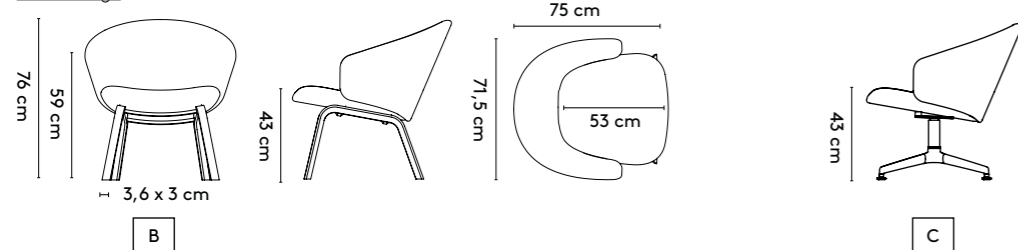
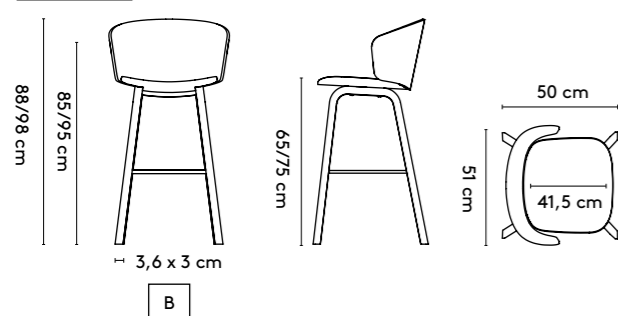
2 **Standard**Close 1Close 2Close+ 2Close loungeClose barstool1 **Close****Gudmundur
Ludvik**

2016-2022

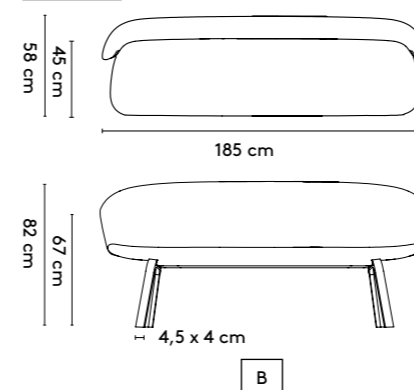
Close bench

130 x 58 x 82 cm
185 x 58 x 82 cm
240 x 58 x 82 cm

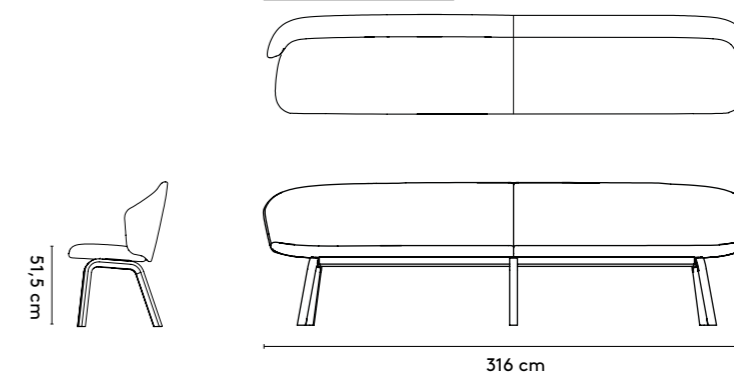
Close bench connected

316 x 58 x 82 cm (6 legs)
426 x 58 x 82 cm (6 legs)

3 **Materials****Seat: fabric or leather****Frame:****A. cantilever: epoxy fine texture on steel****B. beech laminate with oak or walnut top layer****C. 4 feet central base (swivel) on feet: polished aluminum, epoxy fine texture on aluminum****D. 4 feet central base (fixed) on castors: polished aluminum, epoxy fine texture on aluminum****E. 5 feet central base (swivel, height adjustable) on castors: polished aluminum, epoxy fine texture on aluminum****Materialen**

Kuip: stof of leder

Onderstel:

A. slede: epoxy fine texture op staal

B. beuken laminaat met eiken of noten toplag

C. 4 teens centrale voet (draaibaar) op pootjes: gepolijst aluminium, epoxy fine texture op aluminium

D. 4 teens centrale voet (vast) op wielen: gepolijst aluminium, epoxy fine texture op aluminium

E. 5 teens centrale voet (draaibaar met gasveer) op wielen: gepolijst aluminium, epoxy fine texture op aluminium

Materialien

Sitz: Stoff oder Leder

Untergestell:

A. Kufen: Epoxy fine texture auf Stahl

B. Buche Laminaat mit Eiche oder Nussbaum Oberbeschichtung

C. 4 Bein Zentralfuss (drehbar) auf Füße: poliertes Aluminium, Epoxy fine texture auf Aluminium

D. 4 Bein Zentralfuss (fest) auf Rollen: poliertes Aluminium, Epoxy fine texture auf Aluminium

E. 5 Bein Zentralfuss (drehbar mit Gasfeder) auf Rollen: poliertes Aluminium, Epoxy fine texture auf Aluminium

4 **Finishes****All Arco colors and finishes for the mentioned materials****Afwerkingen**

Alle Arco kleuren en lakafwerkingen voor de genoemde materialen

Ausführungen

Alle Arco Farben und Ausführungen für die genannte Materialien

5 **Additional information****Aanvullende informatie****Weitere Informationen**

product

Ease

designer

**Burkhard
Vogtherr &
Jonathan
Prestwich**

year

2013





Ease adds a new facet to the meaning of comfort: the chair's backrest consists of flexible 'fingers' that mould to fit your body.

Ease geeft een nieuwe invulling aan het begrip comfort: de rugleuning van de stoel bestaat namelijk uit flexibele 'vingers', die zich naar je lichaam vormen.

Ease fügt zu dem Begriff „Komfort“ eine neue Dimension hin. Die Rückenlehne dieses Stuhls besteht aus flexiblen „Fingern“, die sich der Form des Körpers anpassen.

product

1 **Ease**

designer

Burkhard Vogtherr & Jonathan Prestwich

year

2013

2 **Standard**

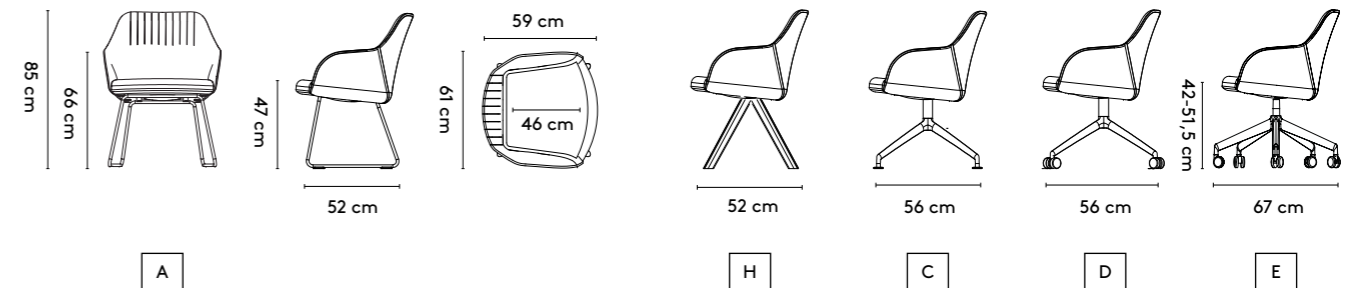

3 **Materials**

Seat: upholstered (fabric, leather)
Frame:
A. Cantilever: epoxy fine texture on steel
H. 4 legs (fixed, swivel): oak (solid)
C. 4 feet central base (swivel) on feet: polished aluminum, epoxy fine texture on aluminum
D. 4 feet central base (fixed) on castors: polished aluminum, epoxy fine texture on aluminum
E. 5 feet central base (swivel, height adjustable) on castors: polished aluminum, epoxy fine texture on aluminum

Materialen

Kuip: gestoffeerd (stof, leer)
 Onderstel:
A. Slede: epoxy fine texture op staal
H. 4 poten (vast of draaibaar): eiken (massief)
C. 4 teens centrale voet (draaibaar) op pootjes: gepolijst aluminium, epoxy fine texture op aluminium
D. 4 teens centrale voet (vast) op wielen: gepolijst aluminium, epoxy fine texture op aluminium
E. 5 teens centrale voet (draaibaar met gasveer) op wielen: gepolijst aluminium, epoxy fine texture op aluminium

Materialien

Sitzschale: gepolstert (Stoff, Leder)
 Untergestell:
A. Kufen: Epoxy fine texture auf Stahl
H. 4 Beine (fest oder drehbar): Eiche (Massiv)
C. 4 Bein Zentralfuss (drehbar) auf Füße: poliertes Aluminium, Epoxy fine texture auf Aluminium
D. 4 Bein Zentralfuss (fest) auf Rollen: poliertes Aluminium, Epoxylack auf Aluminium, Epoxy fine texture auf Aluminium
E. 5 Bein Zentralfuss (drehbar mit Gasfeder) auf Rollen: poliertes Aluminium, Epoxylack auf Aluminium, Epoxy fine texture auf Aluminium

4 **Finishes**

All Arco colors and finishes for the mentioned materials

Afwerkingen

Alle Arco kleuren en lakafwerkingen voor de genoemde materialen

Ausführungen

Alle Arco Farben und Ausführungen für die genannten Materialien

5 **Additional information**

-

Aanvullende informatie

-

Weitere Informationen

-



Flux is a versatile chair with a modern and very comfortable construction. All parts and materials applied in the construction are separable and thus recyclable.

Flux is een veelzijdige stoel met een moderne en uiterst comfortabele constructie. Alle gebruikte onderdelen en materialen zijn goed te scheiden en daarmee recyclebaar.

Flux ist ein vielseitiger Stuhl mit einer modernen und sehr bequemen Konstruktion. Alle verwendete Teile und Materialien sind trennbar und damit wiederverwertbar.

product

1 **Flux**

designer

Jorre van Ast

year

2014

2 **Standard**

Flux 1

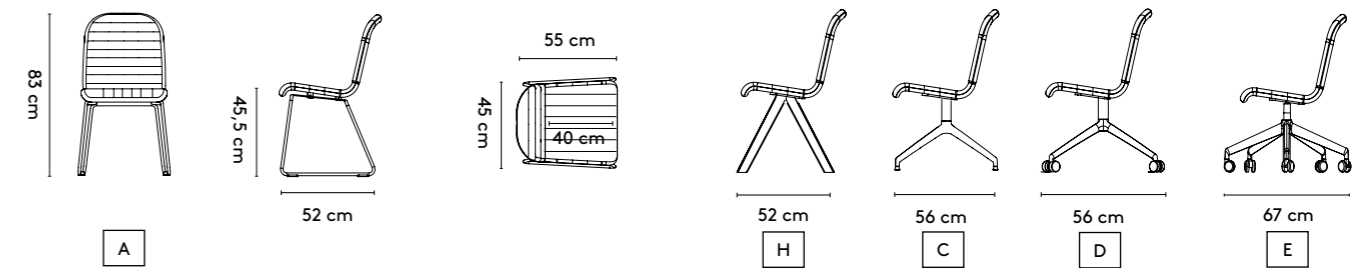

Flux 2

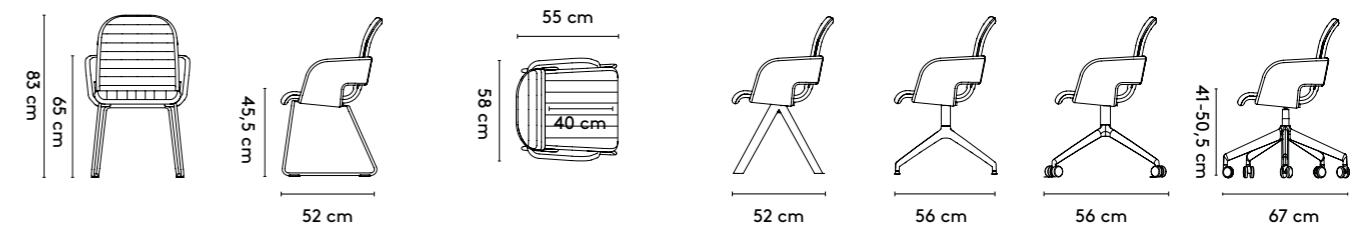

3

Materials

Seat (and arm rests): upholstered (fabric, leather)
Frame:
A. Cantilever: epoxy fine texture on steel

H. 4 legs (fixed, swivel): oak (solid)

C. 4 feet central base (swivel, swivel with auto-return) on feet: polished aluminum, epoxy fine texture on aluminum

D. 4 feet central base (fixed) on castors: polished aluminum, epoxy fine texture on aluminum

E. 5 feet central base (swivel, height adjustable) on castors: polished aluminum, epoxy fine texture on aluminum

Materialen

Zitting (en armleuningen): gestoffeerd (stof, leder)
Onderstel:
A. Slede: epoxy fine texture op staal

H. 4 poten (vast of draaibaar): eiken (massief)

C. 4 teens centrale voet (draaibaar, draaibaar met auto return) op pootjes: gepolijst aluminium, epoxy fine texture op aluminium

D. 4 teens centrale voet (vast) op wielen: gepolijst aluminium, epoxy fine texture op aluminium

E. 5 teens centrale voet (draaibaar met gasveer) op wielen : gepolijst aluminium, epoxy fine texture op aluminium

Materialien

Sitz (und Armlehnen): gepolstert (Stoff, Leder)
Untergestell:
A. Kufen: Epoxy fine texture auf Stahl

H. 4 Beine (fest oder drehbar): Eiche (Massiv)

C. 4 Bein Zentralfuss (drehbar, drehbar mit Auto-return) auf Füße: poliertes Aluminium, Epoxy fine texture auf Aluminium

D. 4 Bein Zentralfuss (fest) auf Rollen: poliertes Aluminium, Epoxy fine texture auf Aluminium

E. 5 Bein Zentralfuss (drehbar mit Gasfeder) auf Rollen : poliertes Aluminium, Epoxy fine texture auf Aluminium

4

Finishes

All Arco colors and finishes for the mentioned materials

Afwerkingen

Alle Arco kleuren en lakafwerkingen voor de genoemde materialen

Ausführungen

Alle Arco Farben und Ausführungen für die genannten Materialien

5

Additional information

-

Aanvullende informatie

-

Weitere Informationen

-

product

Frame

designer

**Burkhard
Vogtherr**

year

2000 - 2022



The Frame Chair has a distinctive metal frame with fine rectangular lines that create an elegant and delicate look.

De Frame stoel wordt gekenmerkt door een metalen frame met een fijne, rechthoekige belijning die de stoel een lichte en luchtige uitstraling geeft.

Der Frame-Stuhl kennzeichnet sich durch einen Metallrahmen mit feinen, rechteckigen Linien, der dem Stuhl eine leichte und luftige Ausstrahlung verleiht.





product

designer

year

1 **Frame**

**Burkhard
Vogtherr**

2000 - 2022

2 **Standard**

Frame

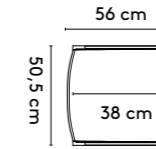
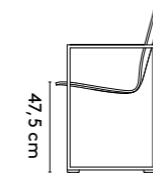
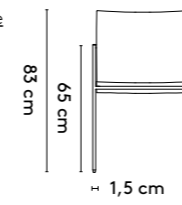

Frame XL

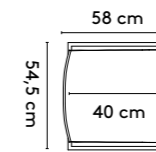
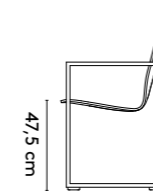
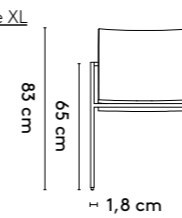

Frame II

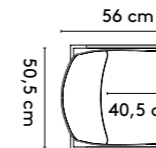
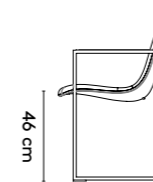
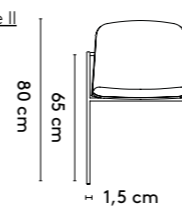

Frame II XL

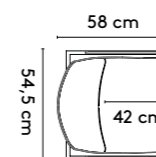
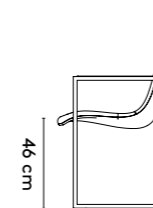
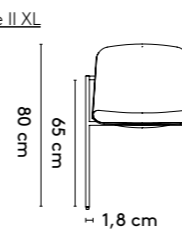

Frame bench

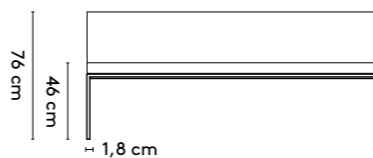
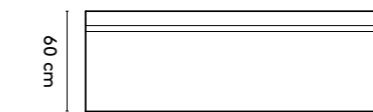

150 x 60 x 76 cm
180 x 60 x 76 cm
210 x 60 x 76 cm
240 x 60 x 76 cm

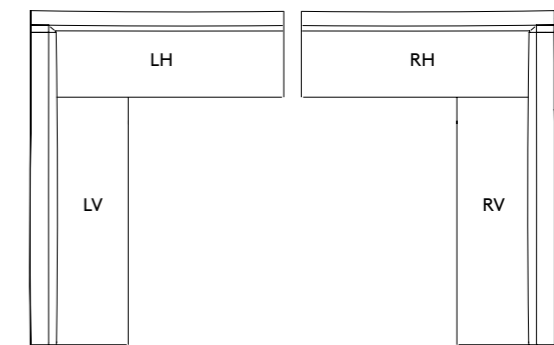

LV 150/180/210/240 cm
LH 150/180/210/240 cm

RV 150/180/210/240 cm
RH 150/180/210/240 cm

3 **Materials**

Seat: upholstered (fabric, leather) or oak (veneer, only available for Frame, not Frame II)
Frame: mat chrome, epoxy fine texture on steel

Materialen

Zitting: gestoffeerd (stof, leder) of eiken (fineer, alleen mogelijk voor Frame, niet voor Frame II)
Onderstel: parelchrom, epoxy fine texture op staal

Materialien

Sitz: gepolstert (Stoff, Leder) oder Eiche (fineer, nur möglich bei Frame, nicht bei Frame II)
Untergestell: Mattchrom, Epoxy fine texture auf Stahl

4 **Finishes**

All Arco colors and finishes for the mentioned materials

Afwerkingen

Alle Arco kleuren en lakafwerkingen voor de genoemde materialen

Ausführungen

Alle Arco Farben und Ausführungen für die genannten Materialien

5 **Additional information**

-

Aanvullende informatie

-

Weitere Informationen

-

product

Laze

designer

**Gudmundur
Ludvik**

year

2019 - 2022



Laze is a luxurious dining room chair, distinguished by its exceedingly high sitting comfort. This comfort is created by individual seat and back cushions and an elastic net in the seat of the chair.

Laze is een luxe eetkamerstoel en onderscheidt zich vanwege een uitermate hoog zitcomfort. Dit comfort word gecreëerd door de losse zit en rug kussens en een elastisch net in de zitting van de stoel.

Laze ist ein luxuriöser Esszimmerstuhl, der sich durch seinen außergewöhnlichen Sitzkomfort auszeichnet. Dieser Komfort wird durch die losen Sitz- und Rückenkissen und einem elastischen Netz im Stuhlsitz erzeugt.



product

1 **Laze**

designer

**Gudmundur
Ludvik**

year

2019 - 2022

2 **Standard**

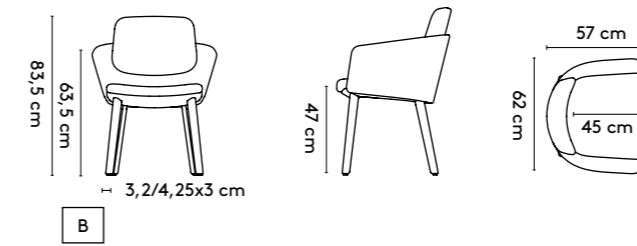

3 **Materials**

Seat: fabric or leather
Cushions: fabric or leather
Frame:
B. oak (solid)

Materialen

Kuip: stof of leder
Kussens: stof of leder
Onderstel:
B. eiken (massief)

Materialien

Sitz: Stoff oder Leder
Kissen: Stoff oder Leder
Untergestell:
B. Eiche (Massiv)

4 **Finishes**

**All Arco colors and finishes for
the mentioned materials**

Afwerkingen

**Alle Arco kleuren en lakafwerkingen voor
de genoemde materialen**

Ausführungen

**Alle Arco Farben und Ausführungen für
die genannte Materialien**

5 **Additional information**

-

Aanvullende informatie

-

Weitere Informationen

-

Designer Gudmundur Ludvik created the Re-volve from purely organic materials. Each part of the chair can be easily reupholstered, ensuring a long life and less environmental impact. Similarly, high-quality materials mean that the Re-volve is uncommonly durable; an investment for both your home and the planet.

Ontwerper Gudmundur Ludvik heeft de Re-volve samengesteld van louter organische materialen. Elk onderdeel van de stoel kan eenvoudig opnieuw gestoffeerd worden voor een lange levensduur en minder schade voor het milieu. Bovendien betekenen de kwaliteitsmaterialen van de Re-volve dat deze stoel uitzonderlijk lang meegaat: het is een investering voor je huis en voor een betere wereld.

Der Re-volve wurde vom Designer Gudmundur Ludvik aus rein organischen Materialien entworfen. Jeder Teil des Stuhls kann problemlos neu gepolstert werden, was eine lange Lebensdauer und eine geringere Umweltbelastung gewährleistet. Dank seiner hochwertigen Materialien ist der Re-volve besonders langlebig – eine Investition für Ihr Zuhause und unseren Planeten.

product

Re-volve

designer

**Gudmundur
Ludvik**

year

2022





product	designer	year
1 Re-volve	Gudmundur Ludvik	2022
2 Standard		
3 Materials		
Seat and inside of back: fabric or leather Frame: oak (solid) Back (outside): oak (veneer)	Materialen Zitting en binnenzijde rugleuning: stof of leder Onderstel: eiken (massief) Rug (buitenzijde): eiken (fineer)	Materialien Sitz und Innenseite Rücken: Stoff oder Leder Untergestell: Eiche (Massiv) Rücken (Außenseite): Eiche (Furnier)
4 Finishes		
All Arco colors and finishes for the mentioned materials	Afwerkingen Alle Arco kleuren en lakafwerkingen voor de genoemde materialen	Ausführungen Alle Arco Farben und Ausführungen für die genannte Materialien
5 Additional information		
-	-	-



product

Side by Side

designer

**Dick
Spienburg &
Karel
Boonzaaijer**

year

2008

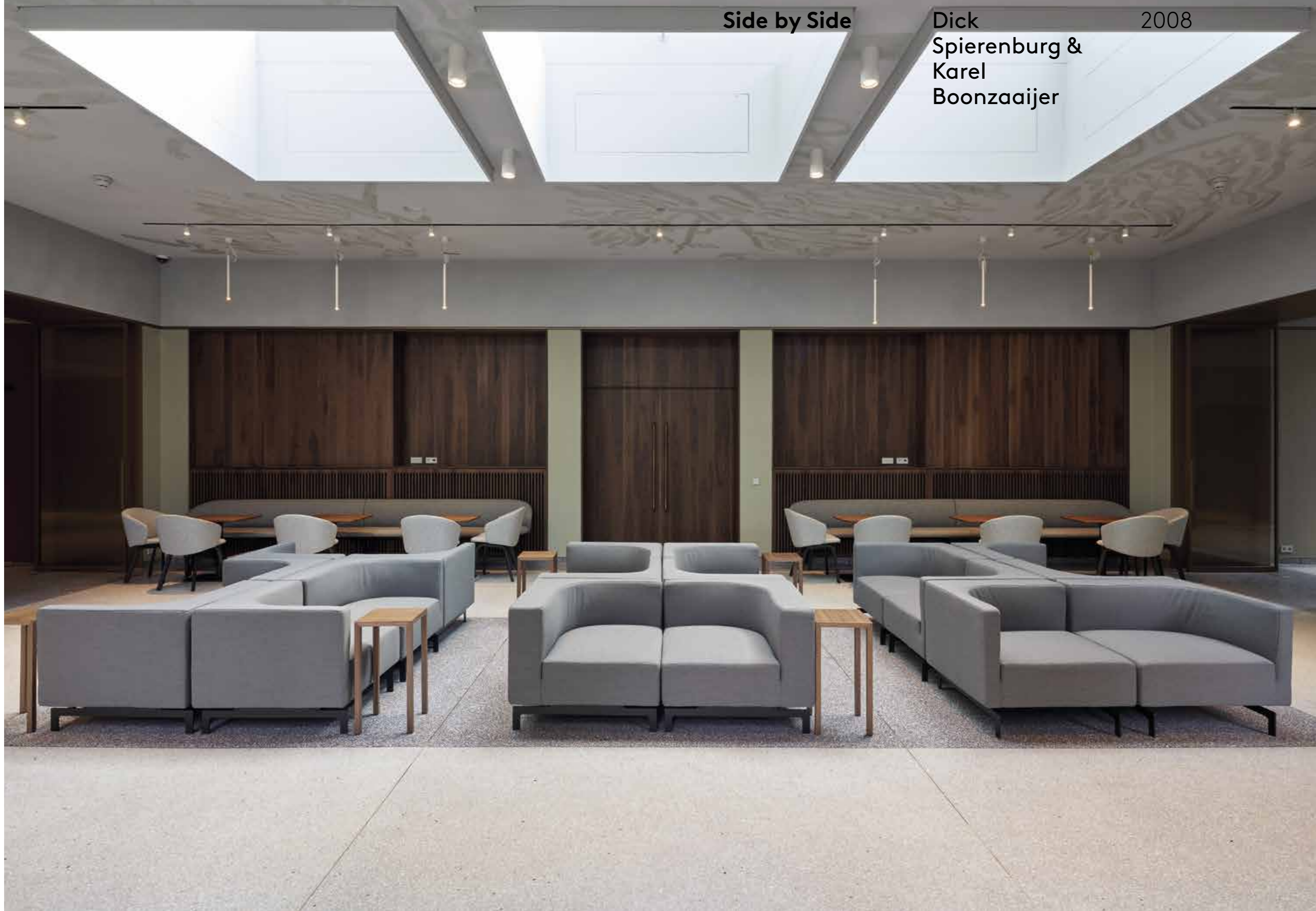



Side by Side is a modular seating-program, which includes couches and one-seat elements.

Side by Side is een modulair zit-programma, bestaande uit banken en losse schakelementen.

Modulares Sitzmöbelprogramm bestehend aus Sofas und einzelne Kombinationselemente (Einsitzer).

product

1 Side by Side

designer

Dick
Spienburg &
Karel
Boonzaaijer

year

2008

2 Standard

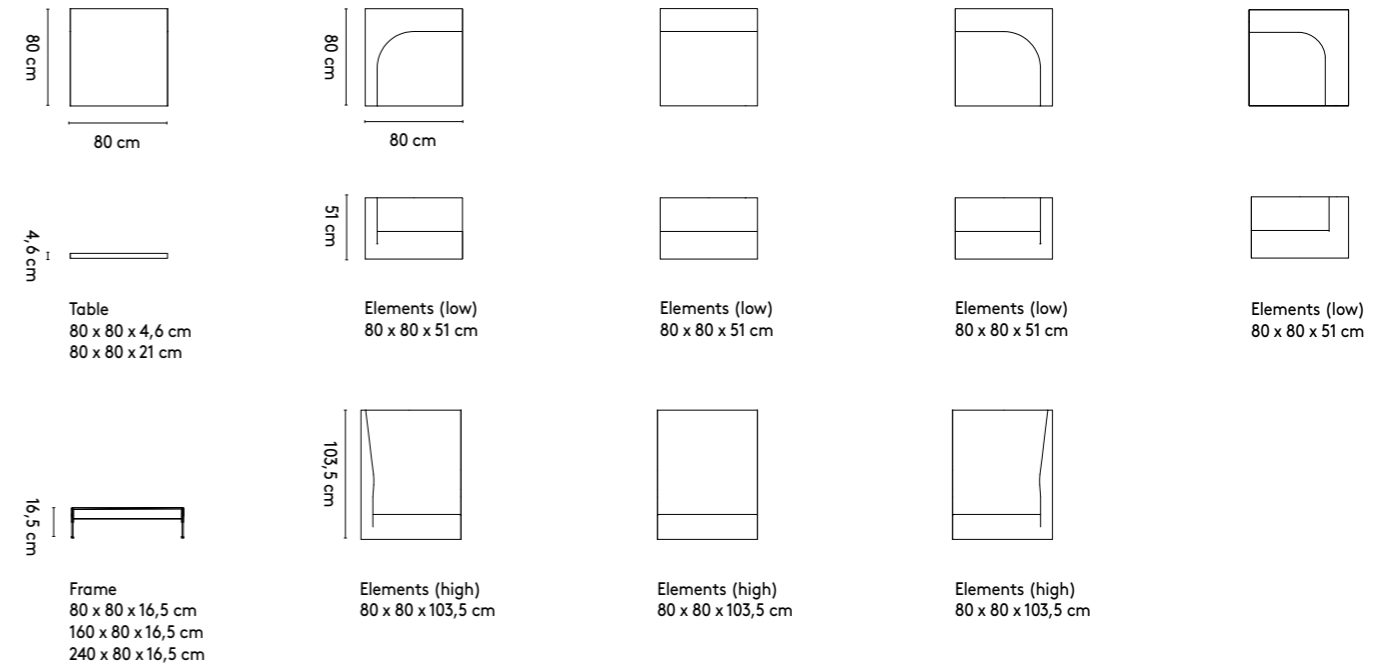

3 Materials

Elements: upholstered (fabric)
Frame: stainless steel optic, epoxy fine texture on steel

Table
Top: oak or walnut (veneer), color lacquer on ash (veneer)
Frame: stainless steel optic, epoxy fine texture on steel (RAL9005)

Materialen

Elementen: gestoffeerd (stof)
Onderstel: rvs optiek, epoxy fine texture op staal

Tafel
Blad: eiken of noten (fineer), kleurlak op essen (fineer)
Onderstel: rvs optiek, epoxy fine texture op staal (RAL9005)

Materialien

Elementen: gepolstert (Stoff)
Ondergestel: Edeldstahl Optik, Epoxy fine texture auf Stahl

Tische
Platte: Eiche oder Nussbaum (Furnier), Farblack auf Esche (Furnier)
Ondergestel: Edeldstahl Optik, Epoxy Fine Texture auf Stahl (RAL9005)

4 Finishes

All Arco colors and finishes for the mentioned materials

Afwerkingen

Alle Arco kleuren en afwerkingen voor de genoemde materialen

Ausführungen

Alle Arco Farben und Ausführungen für die genannten Materialien

5 Additional information

-

Aanvullende informatie

-

Weitere Informationen

-

product

Sketch Office

designer

Burkhard
Vogtherr &
Jonathan
Prestwich

year

2014 - 2018



A traditional bucket-seat chair in various versions with a modern appearance. The refined round seat pleasantly surrounds you and offers great comfort.

Een klassieke kuipstoel in diverse varianten met een modern uiterlijk. De ronde ranke kuip omsluit je aangenaam en biedt een fijn zitcomfort.

Ein klassischer Schalenstuhl in mehreren Ausführungen mit einer modernen Ausstrahlung, wobei die runde schlanke Schale angenehm anschließt und einen feinen Sitzkomfort bietet.



1 **Sketch Office**
Burkhard Vogtherr & Jonathan Prestwich

2014 - 2018

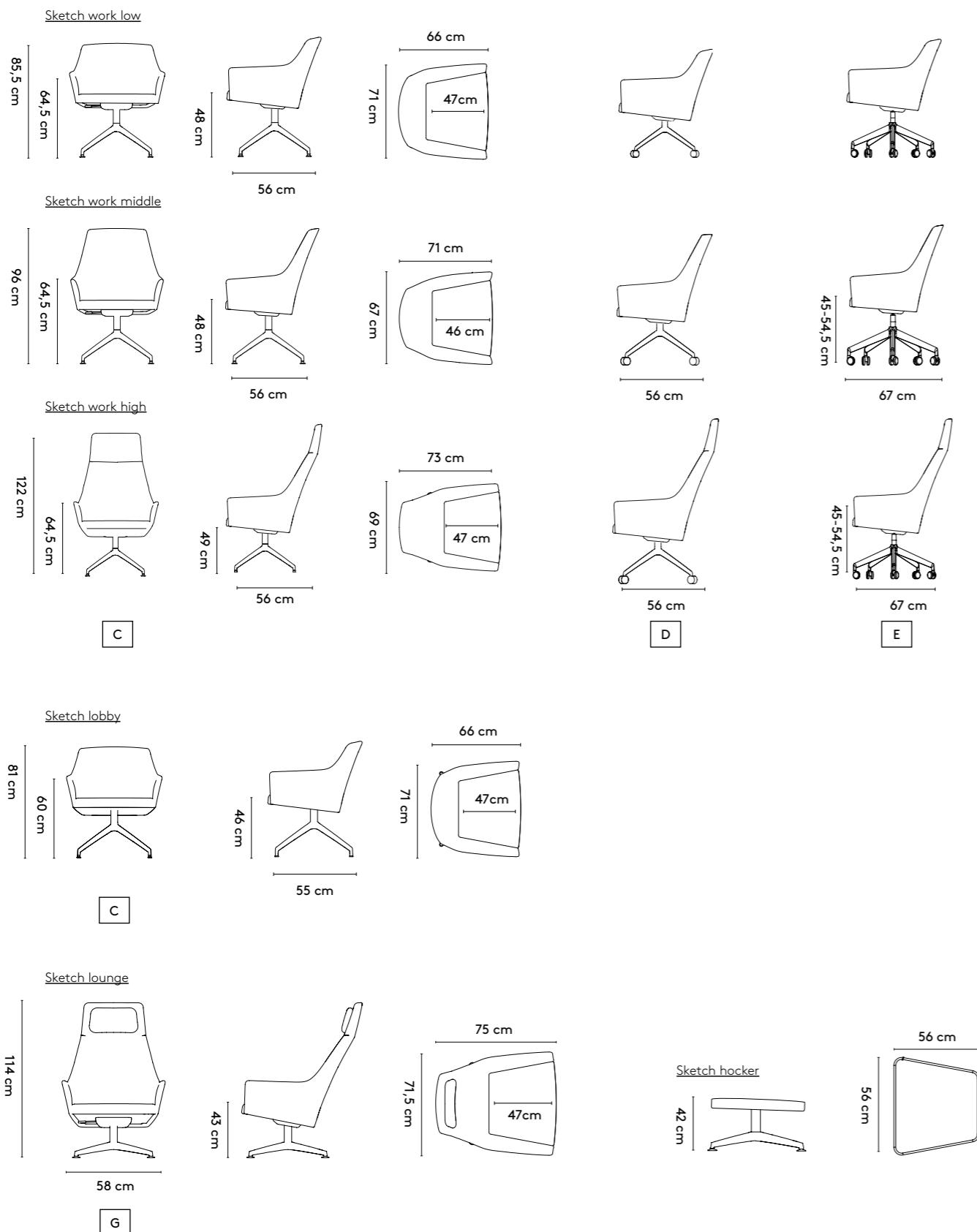
2 **Standard**

1 **Sketch Office**
Burkhard Vogtherr & Jonathan Prestwich

2014 - 2018

3 **Materials**Sketch low/middle/high

Seat: upholstered (fabric, leather)

Frame:

C. 4 feet central base (swivel) on feet:
polished aluminium, epoxy fine texture on aluminium

D. 4 feet central base (fixed) on castors:
polished aluminium, epoxy fine texture on aluminium

E. 5 feet central base (swivel, height adjustable + tilt) on castors:
polished aluminium, epoxy fine texture on aluminium

G. 4 feet central base (swivel and tilting):
polished aluminium, epoxy fine texture on aluminium

MaterialenSketch low/middle/high

Kuip: gestoffeerd (stof, leder)

Onderstel:

C. 4 teens centrale voet (draaibaar) op pootjes:
gepolijst aluminium, epoxy fine texture op aluminium

D. 4 teens centrale voet (vast) op wielen:
gepolijst aluminium, epoxy fine texture op aluminium

E. 5 teens centrale voet (draaibaar, met gasveer + tilt) op wielen:
epoxy fine texture op aluminium

G. 4 teens centrale voet (draaibaar met tiltmechanisme):
gepolijst aluminium, epoxy fine texture op aluminium

MaterialienSketch low/middle/high

Sitzschale: gepolstert (Stoff, Leder)

Untergestell:

C. 4 Bein Zentralfuss (drehbar) auf Füße:
poliertes Aluminium, Epoxylack auf Aluminium, Epoxy fine texture auf Aluminium

D. 4 Bein Zentralfuss (fest) auf Rollen:
poliertes Aluminium, Epoxy fine texture auf Aluminium

E. 5 Bein Zentralfuss (drehbar, mit Gasfeder + tilt) auf Rollen:
poliertes Aluminium, Epoxy fine texture auf Aluminium

G. 4 Bein Zentralfuss (drehbar und Neigung):
poliertes Aluminium, Epoxy fine texture auf Aluminium

4 **Finishes**

All Arco colors and finishes for the mentioned materials

Afwerkingen

Alle Arco kleuren en lakafwerkingen voor de genoemde materialen

Ausführungen

Alle Arco Farben und Ausführungen für die genannten Materialien

5 **Additional information**

Inside and outside seat in different fabric optional

Aanvullende informatie

Binnen- en buitenzijde kuip in andere stof mogelijk

Weitere Informationen

Innen- und Aussenseite Sitzschale in einem anderen Stoff möglich

The slim round seat of this classic yet modern-looking bucket chair creates a snug surround and is extremely comfortable to sit on.

Een klassieke kuipstoel met een modern uiterlijk, waarvan de ronde ranke kuip je aangenaam omsluit en een fijn zitcomfort biedt.

Ein klassischer Sitzschalenstuhl mit modernem Aussehen, der Sie mit seiner runden schlanken Sitzschale angenehm umgibt und einen schönen Sitzkomfort bietet.



product

designer

year

1 Sketch Regular

Burkhard Vogtherr & Jonathan Prestwich

2010

2 Standard

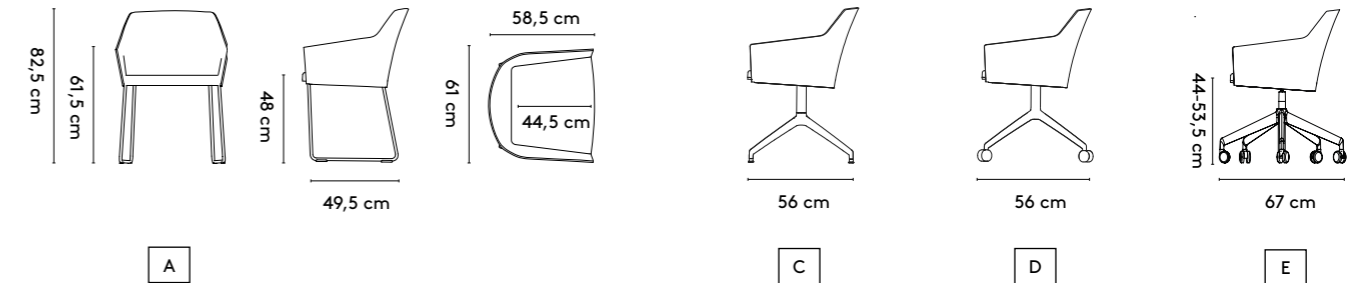

3 Materials

Seat: upholstered (fabric, leather)
Frame:
A. Cantilever: epoxy fine texture on steel
C. 4 feet central base (swivel, swivel with auto-return) on feet: polished aluminum, epoxy fine texture on aluminum
D. 4 feet central base (fixed) on castors: polished aluminum, epoxy fine texture on aluminum
E. 5 feet central base (swivel, height adjustable) on castors: polished aluminum, epoxy fine texture on aluminum

Materialen

Kuip: gestoffeerd (stof, leder)
Onderstel:
A. Slede: epoxy fine texture op staal
C. 4 teens centrale voet (draaibaar, draaibaar met auto return) op pootjes: gepolijst aluminium, epoxy fine texture op aluminium
D. 4 teens centrale voet (vast) op wielen: gepolijst aluminium, epoxy fine texture op aluminium
E. 5 teens centrale voet (draaibaar met gasveer) op wielen: gepolijst aluminium, epoxy fine texture op aluminium

Materialien

Sitzschale: gepolstert (Stoff, Leder)
Untergestell:
A. Kufen: Epoxy fine texture auf Stahl
C. 4 Bein Zentralfuss (drehbar, drehbar mit Auto-return) auf Füße: poliertes Aluminium, Epoxy fine texture auf Aluminium
D. 4 Bein Zentralfuss (fest) auf Rollen: poliertes Aluminium, Epoxy fine texture auf Aluminium
E. 5 Bein Zentralfuss (drehbar mit Gasfeder) auf Rollen: poliertes Aluminium, Epoxy fine texture auf Aluminium

4 Finishes

All Arco colors and finishes for the mentioned materials

Afwerkingen

Alle Arco kleuren en lakafwerkingen voor de genoemde materialen

Ausführungen

Alle Arco Farben und Ausführungen für die genannten Materialien

5 Additional information

Inside and outside seat in different fabrics optional

Aanvullende informatie

Binnen- en buitenzijde kuip in andere stof mogelijk

Weitere Informationen

Innen- und Aussenseite Sitzschale in einem anderen Stoff möglich



we are curious

Wooldse Veen, Winterswijk
N 51.54.512, E 6.44.777

FLEXIBLE

FURNITURE

FOR

FLEXIBLE

LIVES





p. 216

Bow

Bow



p. 226

Tre

Tre



p. 220

Pivot

Pivot



p. 228

Utensil

Utensil



p. 224

Tablet

Tablet

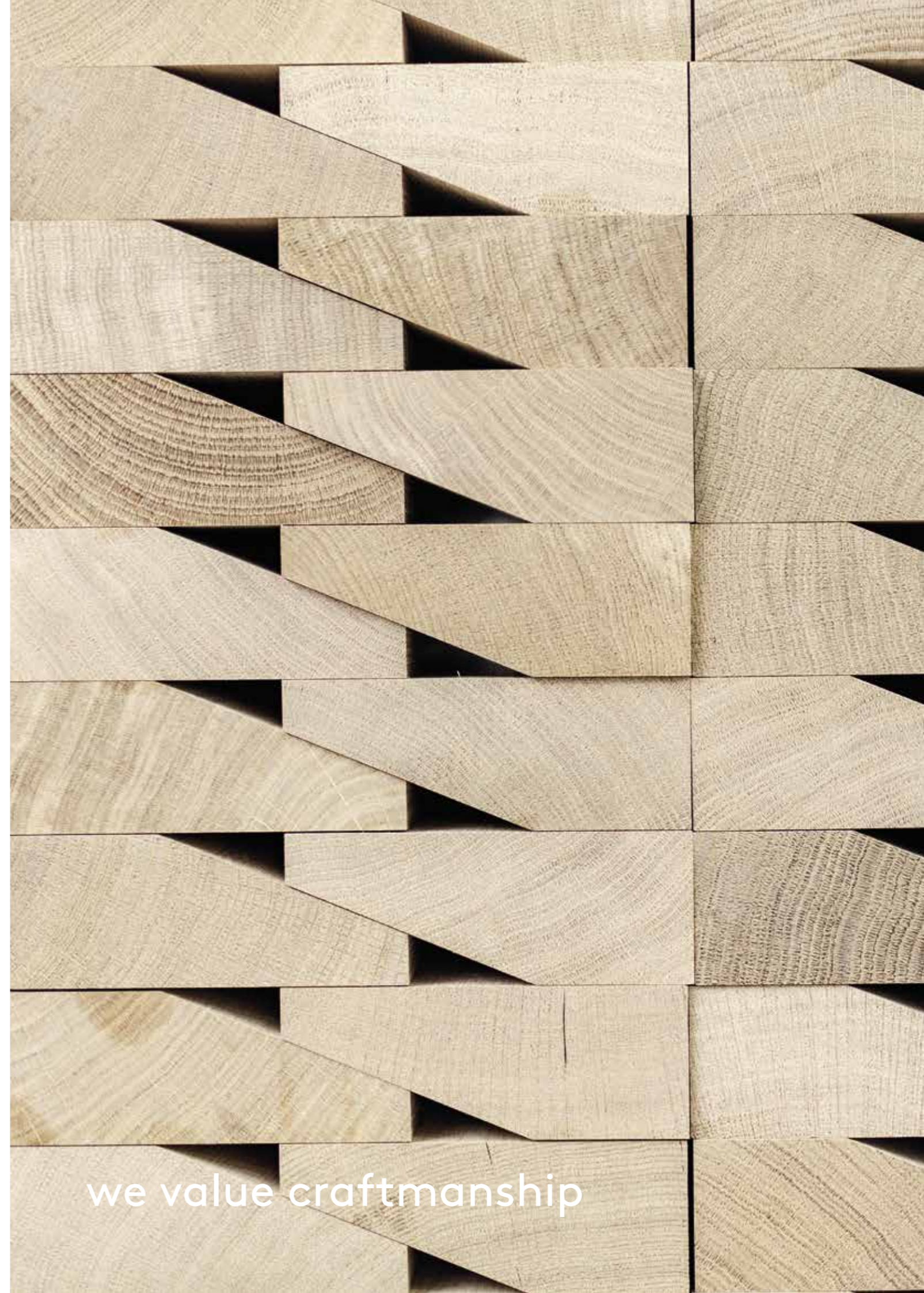

we value craftsmanship

product

Bow

designer

Uli Budde & Ivan Kasner

year

2020



Bow is a robust, ergonomically designed, easy stackable stool. It mixes moulded wood with solid steam-bent wood, and is intended for use in both home and office. The stool is as light as it is robust: a minimal frame grounded for maximum comfort. Bow can also be used as a small side table.

De Bow is een robuuste, ergonomisch ontworpen kruk die gemakkelijk te stapelen is. De kruk combineert plywood met massief stoomgebogen hout en is bedoeld voor gebruik thuis en op kantoor. De kruk is echter net zo licht als hij robuust is: een minimaal frame zorgt voor maximaal comfort. De Bow kan ook als kleine bijzettafel worden gebruikt.

Bow ist ein robuster, ergonomisch geformter Hocker, der sich leicht stapeln lässt. Er kombiniert formgepresstes Holz mit massivem, dampfgebogenem Holz und eignet sich sowohl für den privaten als auch für den geschäftlichen Bereich. Neben seiner Funktion als Hocker kann er auch als kleiner Beistelltisch verwendet werden.



product

designer

year

1 **Bow**

**Uli Budde &
Ivan Kasner**

2020

2 **Standard**

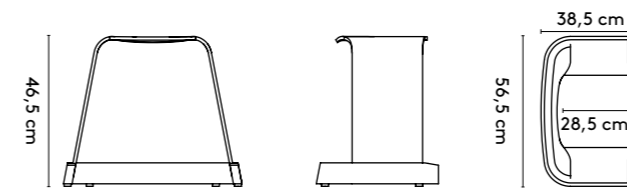

3 **Materials**

Base: oak (solid)
Seat: beech laminate with oak top layer

Materialen

Voet: eiken (massief)
Zitting: beuken laminaat met eiken toplaag

Materialien

Fuss: Eiche (Massiv)
**Sitz: Buche Laminate mit Eiche
Oberbeschichtung**

4 **Finishes**

**All Arco colors with N-finish for the
mentioned materials**

Afwerkingen

**Alle Arco kleuren met N-lak voor de genoemde
materialen**

Ausführungen

**Alle Arco Farben mit N-Lack für die genannten
Materialien**

5 **Additional information**

Stackable: 4 maximum

Aanvullende informatie

Stapelbaar: maximaal 4

Weitere Informationen

Stapelbar: 4 Maximum



product

Pivot

designer

**Raw
Edges**

year

2008





Pivot is a solid wooden cabinet on tall legs with two drawers that can hinge. This makes it possible to open both drawers at the same time.

Pivot is een massief houten kastje dat op hoge poten staat en is voorzien van twee laden die kunnen scharnieren. Hierdoor zijn ze gelijktijdig toegankelijk.

Das Pivot Schränkchen aus Massivholz steht auf hohen Beinen und ist mit zwei Schubkästen ausgestattet die Schwenkbar sind. Dies macht es möglich, beide Schubladen gleichzeitig zu öffnen.

product

designer

year

1 **Pivot**

Raw Edges

2008

2 **Standard**

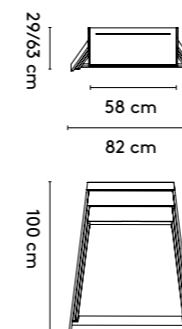

3 **Materials**

Body: oak (solid)
Legs: oak (solid)

Materialen

Romp: eiken (massief)
Poten: eiken (massief)

Materialien

Korpus: Eiche (Massiv)
Füsse: Eiche (Massiv)

4 **Finishes**

All Arco colors and finishes for the mentioned materials

Afwerkingen

Alle Arco kleuren en (lak)afwerkingen voor de genoemde materialen

Ausführungen

Alle Arco Farben und Ausführungen für die genannten Materialien

5 **Additional information**

-

Aanvullende informatie

-

Weitere Informationen

-



A collection of friendly shaped side tables allowing you to create a varied 'landscape'.

Een collectie vriendelijk gevormde bijzettafeltes waarmee je een afwisselend landschap kunt creëren.

Eine Kollektion ansprechend geformten Beistelltischen, mit denen Sie eine abwechslungsreiche Wohnlandschaft gestalten können.

product

1 **Tablet**

designer

Jonas Trampedach

year

2014

2 **Standard**

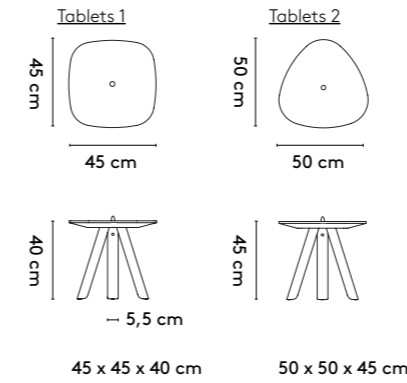

3 **Materials**

Top: oak (veneer)
Legs: oak (solid)
Tab: leather (naturel, brown)

Materialen

Blad: eiken (fineer)
Onderstel: eiken (massief)
Lusje: leder (naturel, brown)

Materialien

Platte: Eiche (Furnier)
Beine: Eiche (Massiv)
Schlaufe: Leder (naturel, brown)

4 **Finishes**

All Arco colors and finishes for the mentioned materials

Afwerkingen

Alle Arco kleuren en (lak)afwerkingen voor de genoemde materialen

Ausführungen

Alle Arco Farben und Ausführungen für die genannten Materialien

5 **Additional information**

-

Aanvullende informatie

-

Weitere Informationen

-



Tre is a playful piece of furniture that can be installed anywhere as handy occasional table – either individually or as a group. The designer Jonas Trampedach describes the tables as real domestic utensils – pieces of equipment for the home.

Tre is een speels meubel: overal inzetbaar als handig bijzettafeltje, alleen of als groep. Volgens ontwerper Jonas Trampedach zijn het echte domestic utensils, een stukje gereedschap voor de woonomgeving.

Tre ist ein spielerisches Kleinmöbel: überall einsetzbar als praktisches Beistelltischchen oder als Gruppe. Der Designer Jonas Trampedach bezeichnet sie als echte domestic utensils, ein Stück Werkzeug für die Wohnumgebung.

product

1 **Tre**

designer

**Jonas
Trampedach**

year

2010

2 **Standard**

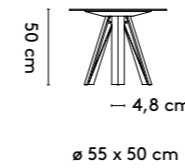
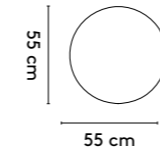

3 **Materials**

**Top: oak (solid)
Legs: oak (solid)**

Materialen

**Blad: eiken (massief)
Onderstel: eiken (massief)**

Materialien

**Platte: Eiche (Massiv)
Beine: Eiche (Massiv)**

4 **Finishes**

All Arco colors and finishes for the mentioned materials

Afwerkingen

Alle Arco kleuren en (lak)afwerkingen voor de genoemde materialen

Ausführungen

Alle Arco Farben und Ausführungen für die genannten Materialien

5 **Additional information**

-

Aanvullende informatie

-

Weitere Informationen

-



product

Utensil

designer

Arco
Design
Studio

year

2012



Utensils is a family of handy small and tall side tables for moments when working and living coincide.

Utensils is een familie van handige kleine tafeltjes (lage en hogere) voor al die momenten dat werken en wonen in elkaar overgaan.

Eine ganze Familie aus praktischen niedrigen oder hohen Tischen für die Momente, an denen Arbeiten und Wohnen ineinander übergehen.



product

designer

year

1 **Utensil**

**Arco
Design
Studio**

2012

2 **Standard**

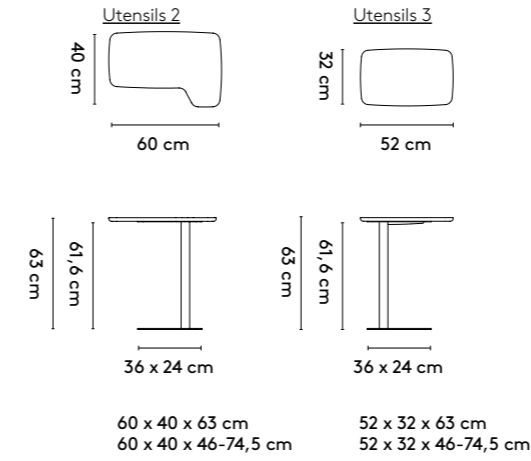

3 **Materials**

Top: oak or walnut (solid)
Foot: epoxy fine texture on steel
Table sock: black, green/blue, red/blue

Materialen

Blad: eiken of noten (massief)
Onderstel: epoxy fine texture op staal
Sok: zwart, groen/blauw, rood/blauw

Materialien

Platte: Eiche oder Nussbaum (Massiv)
Untergestell: Epoxy fine texture auf Stahl
Socke: schwarz, grün/blau, rot/blau

4 **Finishes**

All Arco colors and finishes for the mentioned materials

Afwerkingen

Alle Arco kleuren en (lak)afwerkingen voor de genoemde materialen

Ausführungen

Alle Arco Farben und Ausführungen für die genannten Materialien

5 **Additional information**

-

Aanvullende informatie

-

Weitere Informationen

-





we are dedicated

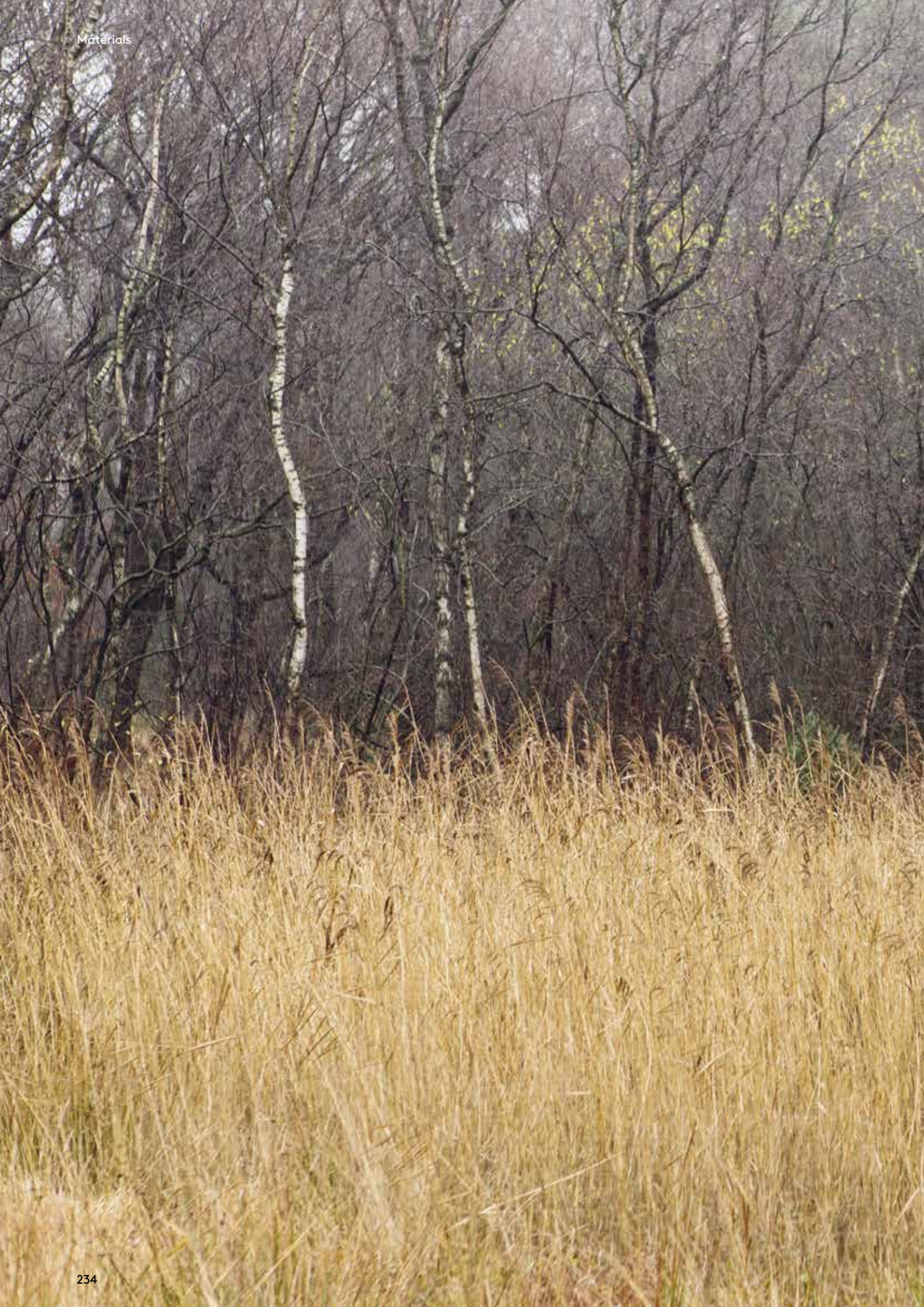

Materials



Bow – oak natural



Base – oak natural (Local Wood)



Dew – oak natural whitened oil



Move – oak pure



Ease – Kvadrat Baru 410 with aluminium base on castors



wood	lacquer	lacquer	lacquer	epoxy	epoxy
oak grey	F2.10.50 mud	P0.03.55 slate blue	F2.05.65 beige	RAL 7039 quartz grey	RAL 7042 slate



wood	wood	lacquer	lacquer	epoxy
oak carbon	oak smoke	RAL9005 black	ASD astro silver dark (metallic)	RAL 9005 black



Close Bench – Febrik by Kvadrat Triangle 192



Slim – oak black



Bock & Bock Tablet – oak carbon



Sketch – Febrik by Kvadrat Triangle 232 combined with Uniform Melange 153



Re-volve – oak black with fabric Main Line Flax Edgeware



HAT – oak black

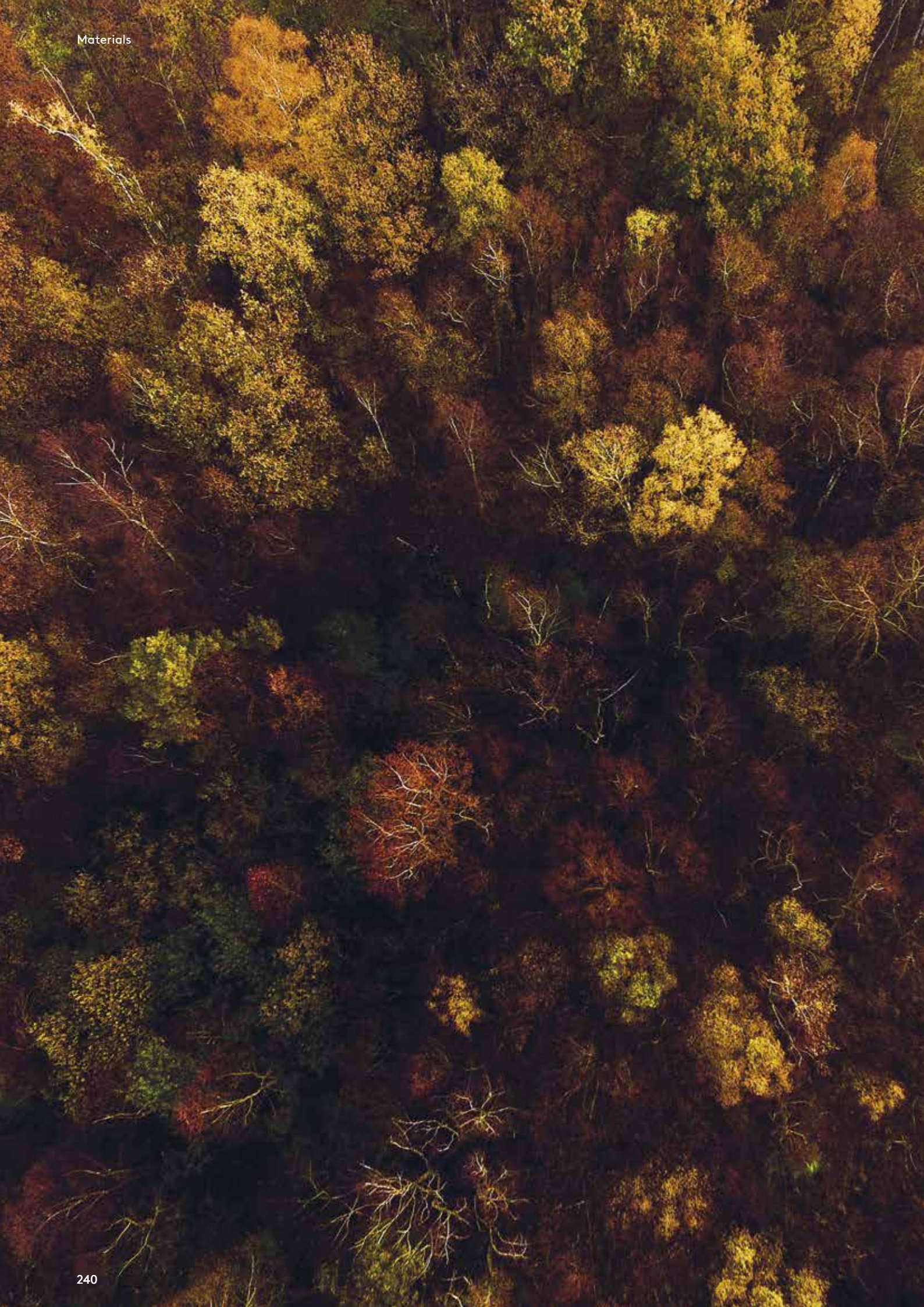

Essential – American walnut



Close – Kvadrat Hero 441 with base in epoxy fine texture RAL 9005 black on castors



Ark – oak morado



Flux – Leather d.NG with aluminium base on glides



Dew – oak dark smoke



wood	wood	wood	lacquer	lacquer	epoxy
oak dijon	oak morado	american walnut	G0.55.80 lime	E4.30.40 mustard	E4.30.40 mustard

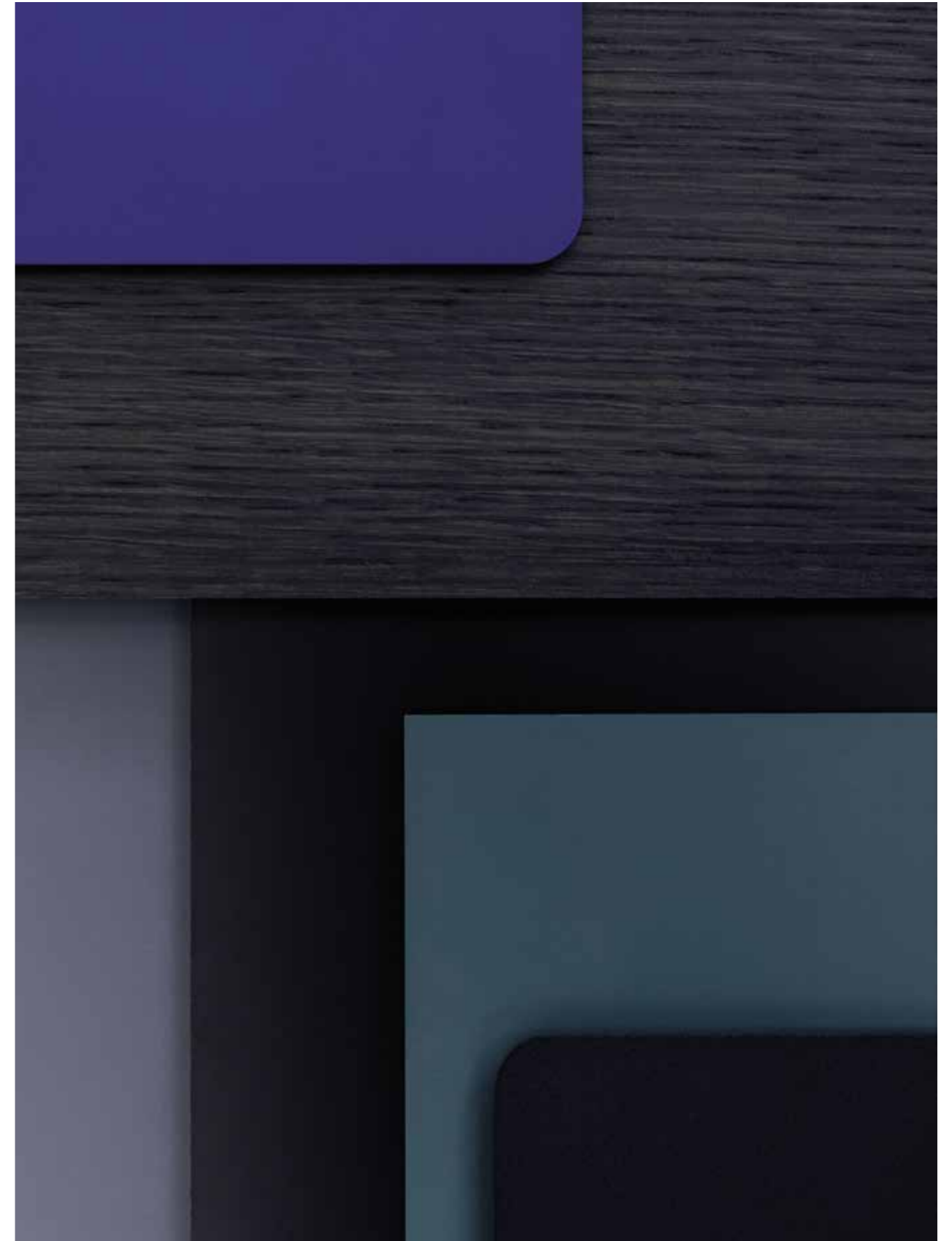

wood	lacquer	lacquer	lacquer	epoxy	epoxy
oak ocean	T0.10.30 prussian blue	RAL 5004 deep blue	R0.30.30 petrol blue	RAL 5002 ultramarine	RAL 5004 deep blue

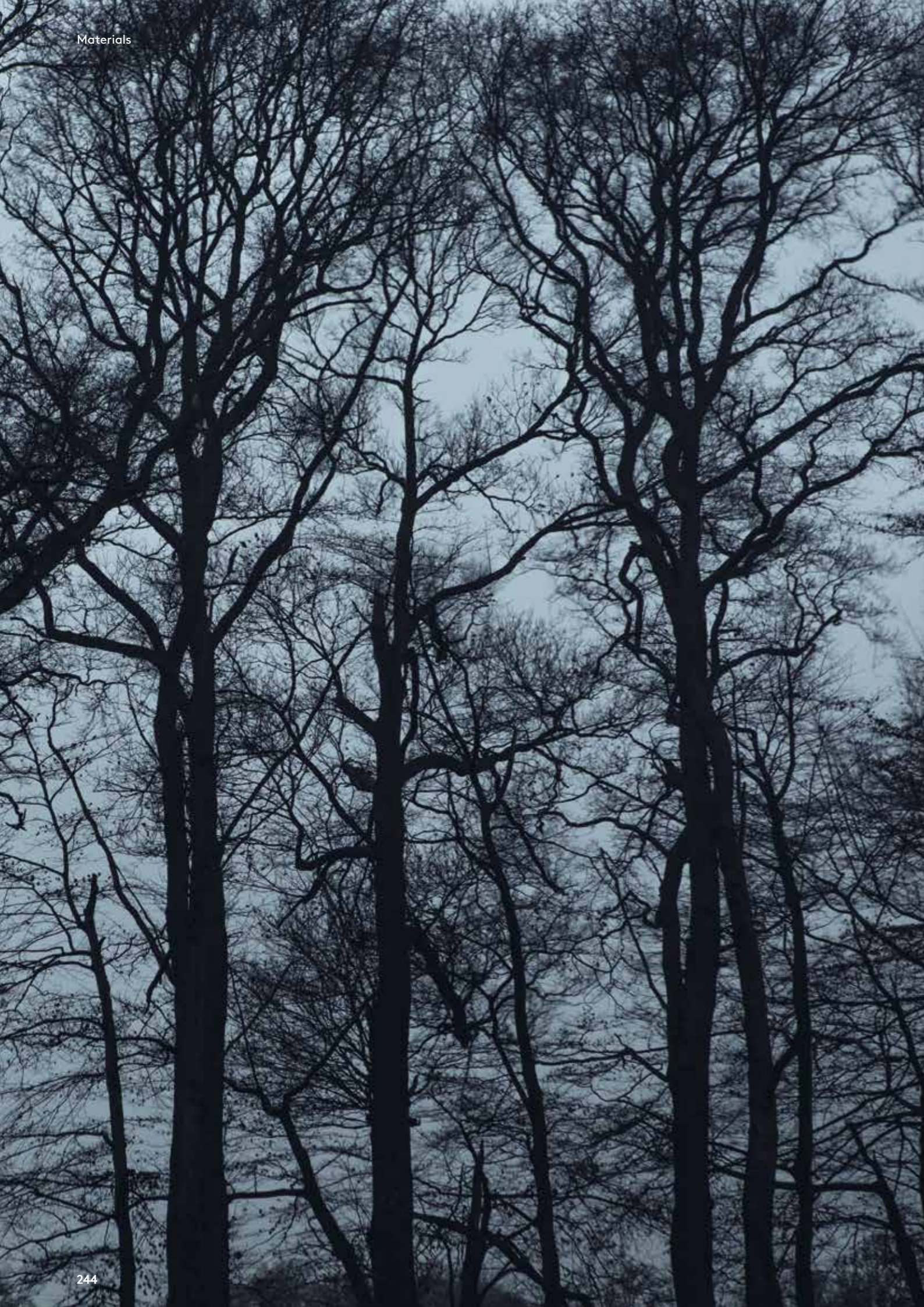

Tablets – oak ocean



Frame – Kvadrat Sisu 0765 with frame epoxy fine texture RAL 5002 ultra marine



Close Barstool – leather D.SK with frame in oak black



Kami Oval 2 – oak carbon



Side by Side – Kvadrat Hallingdal 153 with frame in stainless steel



Pivot – oak black

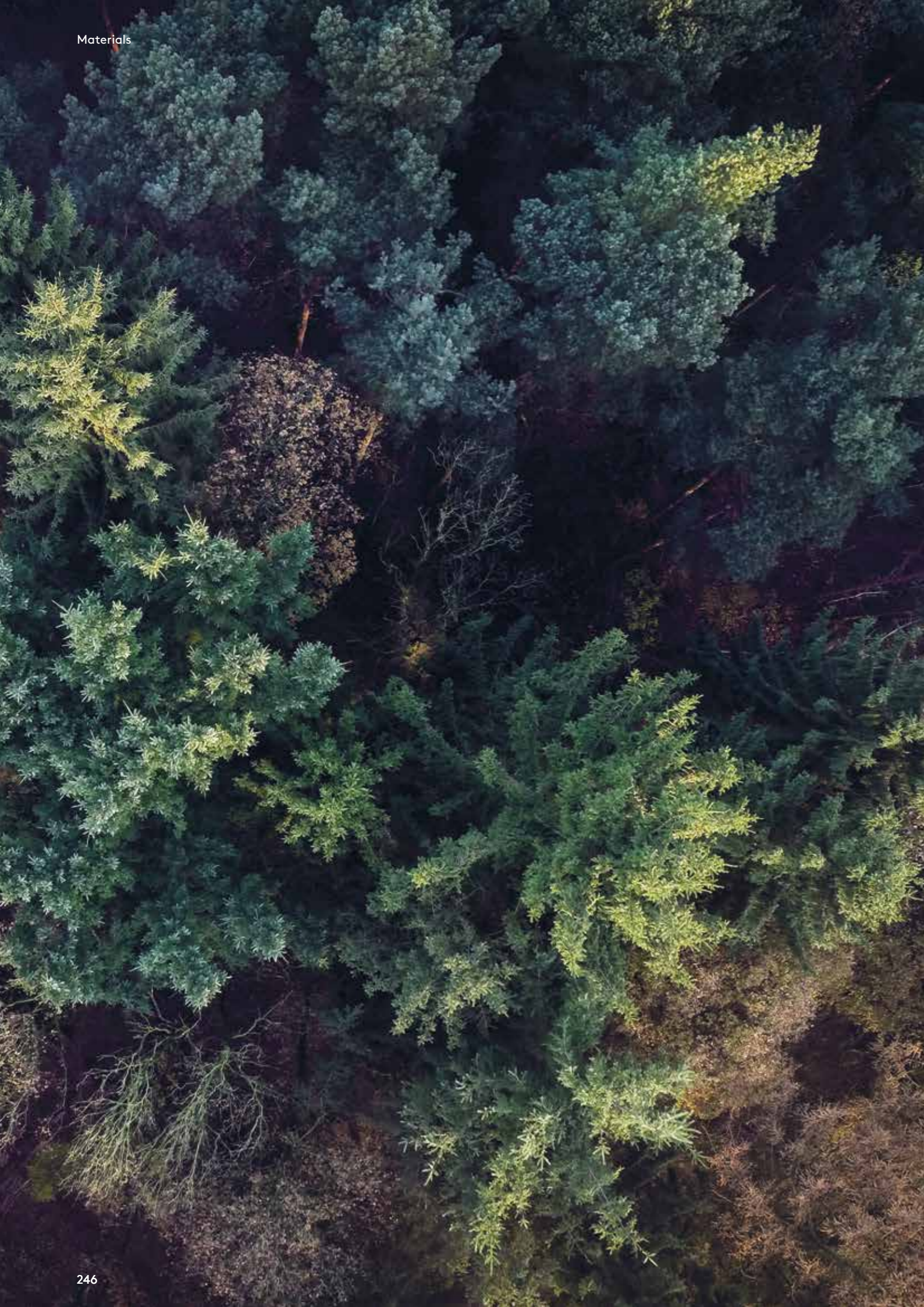

Utensils – epoxy fine texture deep green with oak moss



Balance – oak moss



Slim Bench – color lacquer on ash H8.07.47 mute green



Re-volve – oak Moss with fabric Sisu 0805



Sketch – Kvadrat Hallingdal 65 390 with cantilever base in epoxy fine texture RAL 9010 white



wood	lacquer	lacquer	lacquer	lacquer	epoxy
oak moss	C0.20.30 moss green	H8.07.47 mute green	RAL6007 deep green	L0.20.40 emerald green	RAL6007 deep green

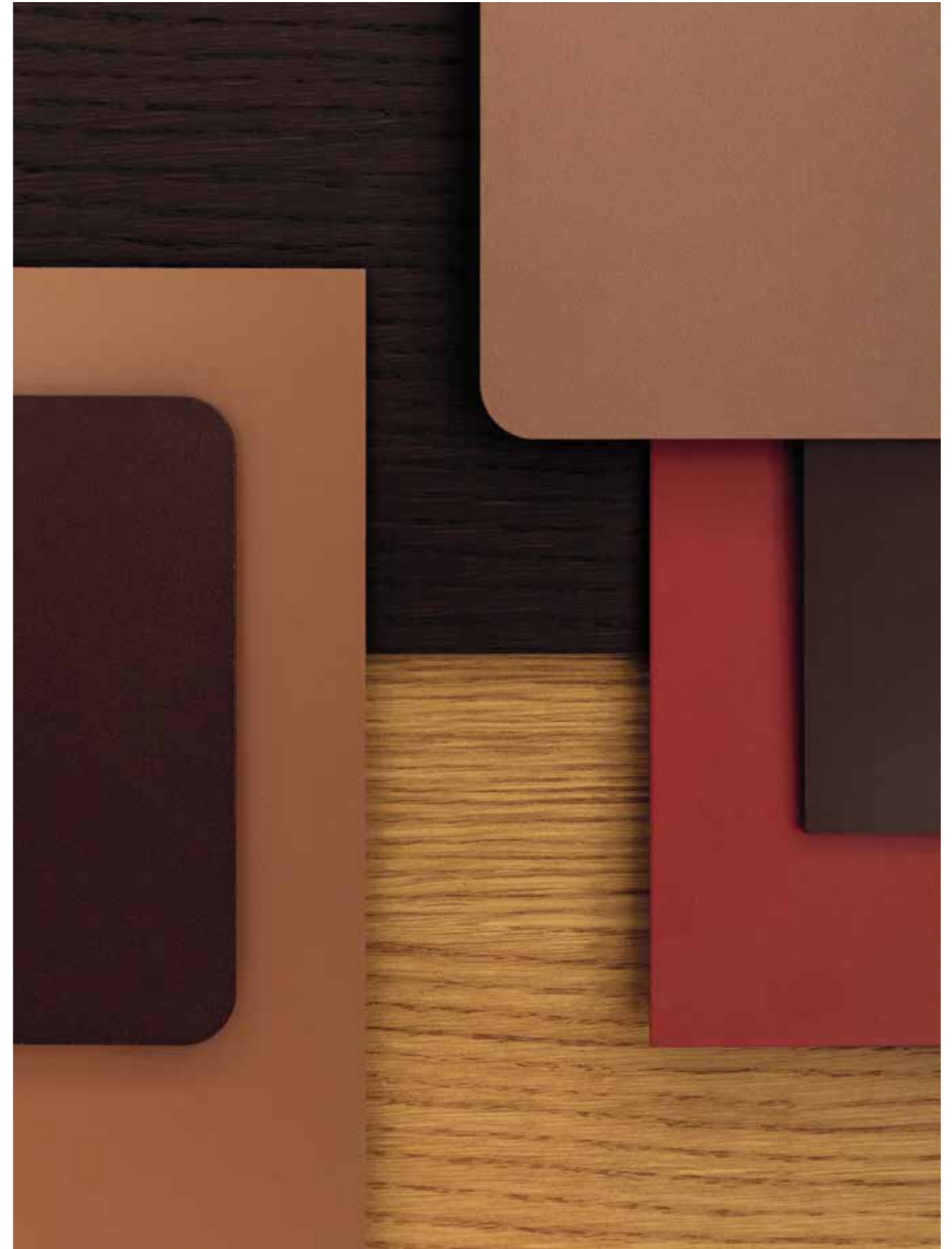

wood	wood	lacquer	lacquer	lacquer	epoxy	epoxy
oak burgundy	oak terra	C8.2040 clay	C4.60.30 red	RAL3007 wine red	C8.20.40 clay	RAL 3007 wine red



Move – oak terra



Frame – fabric Sisu 0655 with frame in RAL 3007 epoxy fine texture wine red



Slim & Slim Flex – oak burgundy



Bow – oak burgundy



Frame Bench – Kvadrat Divina 623 with frame in epoxy fine texture 9005 black

oak: neutrals (solid, semi-solid, veneer)

oak white



oak natural



oak pure



oak grey



oak smoke



oak morado



oak black



oak carbon

oak: colors (solid, semi-solid, veneer)

Dijon



Terra



Burgundy



Moss

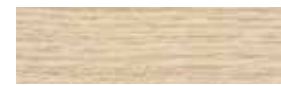

Ocean

oak: neutrals (solid, semi-solid)

oak white oil



oak natural whitened oil



oak dark smoke

walnut (solid, semi-solid, veneer)

american walnut

wood finish (solid, semi-solid)

brushed

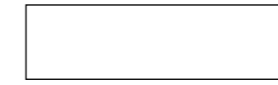
color lacquer: neutrals

GN.02.88 white (RAL 9010)



F2.05.65 beige



F2.10.40 silt



UN.00.07 black (RAL 9005)



FN.02.77 grey



F2.10.50 mud

F7.05.37 quartz grey
(RAL 7039)C2.04.06 deep brown
(RAL 8022)**color lacquer: yellow, green, red, blue color groups**

G0.55.80 lime



H8.07.47 mute green



C8.20.40 clay



P0.03.55 slate blue



E.8.50.50 ochre



L0.20.40 emerald green



C4.60.30 red



RO.30.30 petrol blue



E4.30.40 mustard



G.0.20.30 moss green



C4.35.15 burnt red

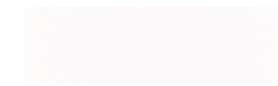
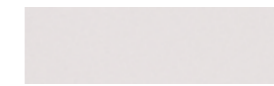

T0.10.30 prussian blue

C2.04.06 deep brown
(RAL 8022)J5.16.15 deep green
(RAL 6007)B1.16.12 wine red
(RAL 3007)U1.11.08 deep blue
(RAL 5004)**epoxy fine texture: neutrals**RAL 9010 white -
epoxy fine texturesikkens FN.02.77 grey -
epoxy fine textureRAL 7039 quartz grey -
epoxy fine textureRAL 7021 black grey -
epoxy fine textureRAL 9005 black -
epoxy fine texture**epoxy fine texture: colors**

rust - epoxy fine texture

RAL 6007 deep green -
epoxy fine textureRAL 3007 wine red -
epoxy fine textureRAL 5004 deep blue -
epoxy fine textureRAL 8022 deep brown -
epoxy fine textureRAL 7042 slate -
epoxy fine textureC8.20.40 clay -
epoxy fine textureE4.30.40 mustard -
epoxy fine textureRAL 5002 ultramarine -
epoxy fine texture

concrete



Natural

metal



Mat chrome



Aluminum



Stainless steel

laminates

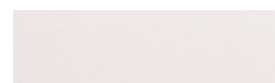

HPL Fenix® White

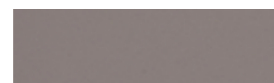

HPL Fenix® Grey



HPL Fenix® Black

leather



a.MO



d.NG



b.EG



a.ZW



b.HZ



b.HB



b.CL



b.AC



a.BR



c.JD



c.AB



c.BL



d.SK

Our seating furniture is available in our own leather collection. We also work with the following collections from Ohmann (www.ohmannleather.com) 1012 (leather group C) and 1010 (leather group D).

Onze stoelen en banken zijn leverbaar in onze eigen leercollectie, maar wij werken ook met de volgende collecties van Ohmann (www.ohmannleather.com) 1012 (leergroep C) en 1010 (leergroep D).

Unsere Sitzmöbel sind in unserer eigenen Lederkollektion lieferbar. Wir arbeiten auch mit den folgenden Kollektionen von Ohmann (www.ohmannleather.com) 1012 (leather gruppe C) und 1010 (leather gruppe D).

textile

Our seating furniture is available in many fabrics from different manufacturers. Among others, we work with with Kvadrat (<http://kvadrat.dk>), De Ploeg (www.deploeg.com), Gabriel (www.gabriel.dk/en/) en Camira (www.camirafabrics.com). The fabric group classification can be found in the fabric list at www.arco.com/downloads

Onze stoelen en banken zijn leverbaar in vele stoffen van verschillende fabrikanten. Wij werken onder andere met Kvadrat (<http://kvadrat.dk>), De Ploeg (www.deploeg.com), Gabriel (www.gabriel.dk/en/) en Camira (www.camirafabrics.com). De stofgroep indeling is te vinden in de stoffenlijst op www.arco.nl/downloads

Unsere Sitzmöbel sind in zahlreichen Stoffen von verschiedenen Herstellern lieferbar. Wir arbeiten unter anderem mit Kvadrat (<http://kvadrat.dk>), De Ploeg (<http://www.deploeg.com>), Gabriel (www.gabriel.dk/en/) und Camira (www.camirafabrics.com). Die Klassifizierung der Stoffgruppen finden Sie in der Stoffliste auf www.arco.nl/downloads

Colophon

Arco catalogue
Oct. 2022

Newsletter

Stay up-to-date with our latest news.



Scan the QR-code
to subscribe to our
newsletter.

Social media

Follow us for product updates, events
and a dose of inspiration via our social
media accounts.

Instagram: @arco_furniture
Pinterest: arcofurniture
LinkedIn: linkedin.com/company/arco_2

Arco Meubelfabriek BV

Parallelweg 2/III
7102 DE Winterswijk
The Netherlands

Postal address

Postbus 11
7100 AA Winterswijk
The Netherlands

Contact

+31 (0) 543 546 570
info@arco.nl
www.arco.nl

Arco showrooms

Design Post Köln

Deutz-Mülheimer-Straße 22a
50679 Köln, Germany
Tel +49 (0) 221 69 06 50
Fax +49 (0) 221 69 06 51 00
info@designpostkoeln.de
www.designpostkoeln.de

Design Post Amsterdam

Cruquiusweg 111 M
1019 AG Amsterdam
Tel +31 (0)20 599 6420
info@designpostamsterdam.nl
www.designpostamsterdam.nl

Photography

Inga Powilleit, www.ingapowilleit.nl
Mike Roelofs, www.mikeroelofs.eu
Lucas Hardonk, www.lucashardonk.com
Patrick Pantze, www.patrick-pantze.de
Silke Steinraths, www.silkesteinraths.de

Text and textual management

Christian Bunyan
Pim Gerrits
Daniëlle van Hengst
Zimmer 310

Art direction

Jorre Van Ast, creative director Arco

Graphic design

Anne Kolkman, graphic designer Arco

Reservations

Changes in colors and dimensions
Changes in assortment and construction
Typing and printing errors

Special thanks to

The entire Arco team for making this happen

Catalogue printed on FSC certified paper

arco



Parallelweg 2-III
7102 DE Winterswijk
The Netherlands

www.arco.nl
info@arco.nl
+31 (0) 543 546 570

If you did one thing for 118 years, you'd get pretty good too.